

Rotary cylinders - Series 69

Product code: 69-063/135-M

Datasheet creation date: 07/03/2025 17:49

Check the most updated document online [click here](#)



TECHNICAL DATA

Series	69
Diameter (mm)	63
Rotation (°)	135
Pinion	M=male pinion
Seals material	= NBR

Rotary cylinders - Series 69

Product code: 69-063/135-M

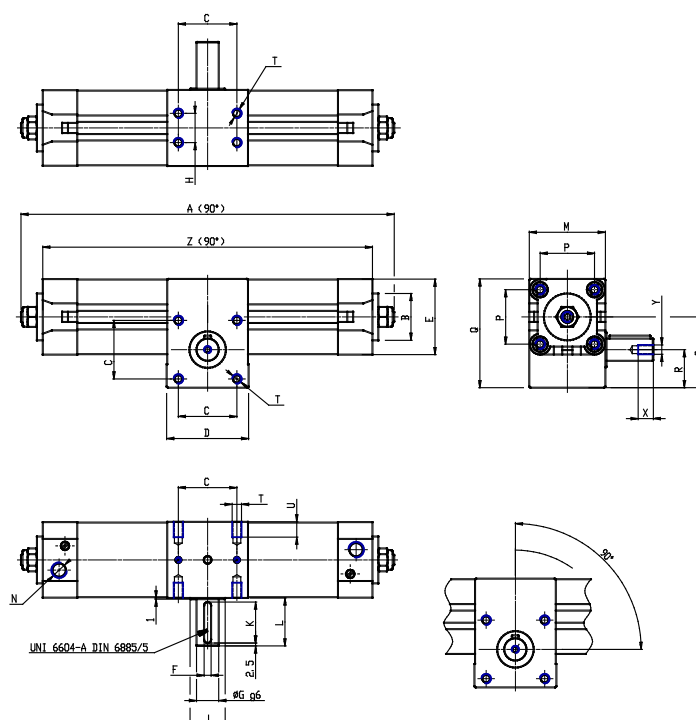

DIMENSIONS

A (mm)	394.2
B d11 (mm)	45
C (mm)	60
D (mm)	75
E (mm)	75.0
F (mm)	8
G (mm)	24
H (mm)	35
J (mm)	30
K (mm)	35
L (mm)	41
M (mm)	75
N	G3/8
P (mm)	56.5
Q (mm)	110.0
R (mm)	37.0
S (mm)	70.8
T	M8
U (mm)	13
V (mm)	21.8
W (mm)	19
Y	M8
X (mm)	19.0
Z (mm)	362.2