

Rotary cylinders - Series 69

Product code: 69-063/150-F

Datasheet creation date: 07/03/2025 17:49

Check the most updated document online [click here](#)



TECHNICAL DATA

| | |
|-----------------------|-----------------|
| Series | 69 |
| Diameter (mm) | 63 |
| Rotation (°) | 150 |
| Pinion | F=female pinion |
| Seals material | = NBR |

Rotary cylinders - Series 69

Product code: 69-063/150-F

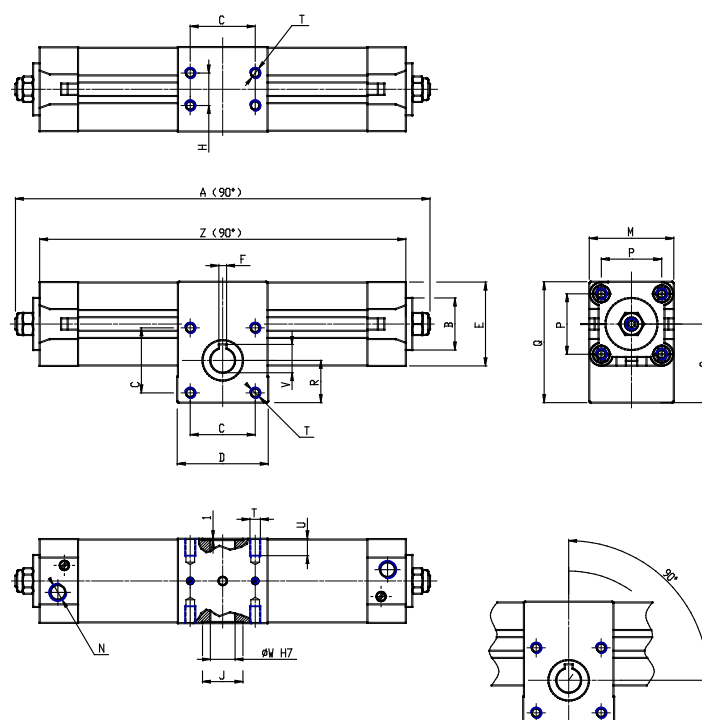

DIMENSIONS

| | |
|------------|-------|
| A (mm) | 406.7 |
| B d11 (mm) | 45 |
| C (mm) | 60 |
| D (mm) | 75 |
| E (mm) | 75.0 |
| F (mm) | 6 |
| G (mm) | 24 |
| H (mm) | 35 |
| J (mm) | 30 |
| K (mm) | 35 |
| L (mm) | 41 |
| M (mm) | 75 |
| N | G3/8 |
| P (mm) | 56.5 |
| Q (mm) | 110.0 |
| R (mm) | 37.0 |
| S (mm) | 70.8 |
| T | M8 |
| U (mm) | 13 |
| V (mm) | 21.8 |
| W (mm) | 19 |
| Y | M8 |
| X (mm) | 19.0 |
| Z (mm) | 374.7 |