

Rotary cylinders - Series 69

Product code: 69-080/360-M

Datasheet creation date: 07/03/2025 17:51

Check the most updated document online [click here](#)



TECHNICAL DATA

Series	69
Diameter (mm)	80
Rotation (°)	360
Pinion	M=male pinion
Seals material	= NBR

Rotary cylinders - Series 69

Product code: 69-080/360-M

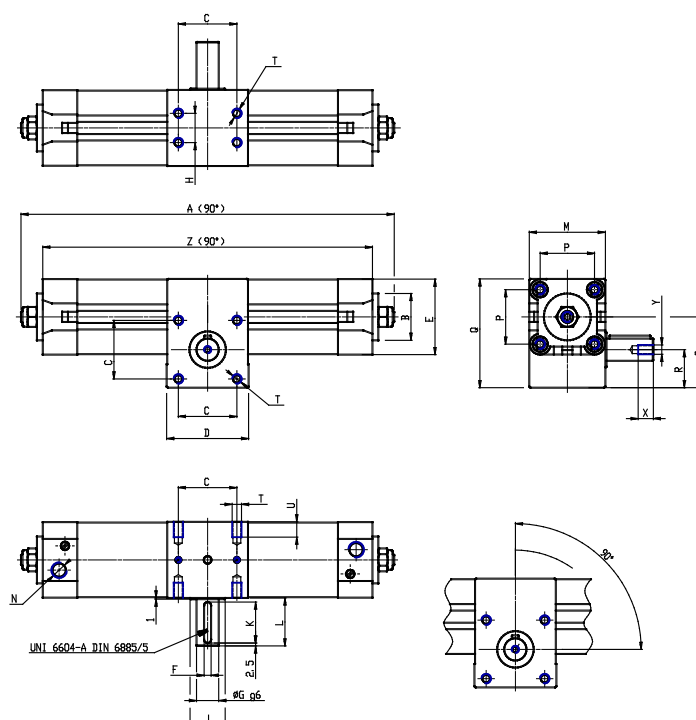

DIMENSIONS

A (mm)	740.0
B d11 (mm)	45
C (mm)	80
D (mm)	99
E (mm)	93.0
F (mm)	8
G (mm)	28
H (mm)	50
J (mm)	45
K (mm)	45
L (mm)	51
M (mm)	99
N	G3/8
P (mm)	72.0
Q (mm)	142.0
R (mm)	50.0
S (mm)	93.5
T	M10
U (mm)	16
V (mm)	27.3
W (mm)	24
Y	M8
X (mm)	19.0
Z (mm)	701.0