

Rotary cylinders - Series 69

Product code: 69-100/215-F

Datasheet creation date: 07/03/2025 17:45

Check the most updated document online [click here](#)



TECHNICAL DATA

Series	69
Diameter (mm)	100
Rotation (°)	215
Pinion	F=female pinion
Seals material	= NBR

Rotary cylinders - Series 69

Product code: 69-100/215-F

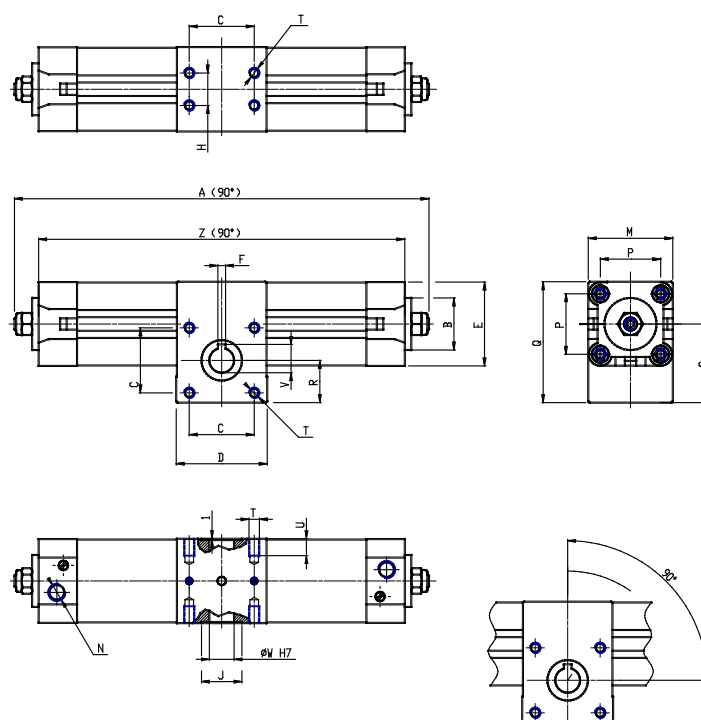

DIMENSIONS

A (mm)	620.6
B d11 (mm)	55
C (mm)	80
D (mm)	115
E (mm)	110.0
F (mm)	8
G (mm)	38
H (mm)	60
J (mm)	50
K (mm)	45
L (mm)	51
M (mm)	115
N	G1/2
P (mm)	89.0
Q (mm)	156.5
R (mm)	54.0
S (mm)	99.0
T	M10
U (mm)	16
V (mm)	31.3
W (mm)	28
Y	M10
X (mm)	22.0
Z (mm)	582.6