

Rotary cylinders - Series 69

Product code: 69-125/140-F

Datasheet creation date: 07/03/2025 17:46

Check the most updated document online [click here](#)



TECHNICAL DATA

Series	69
Diameter (mm)	125
Rotation (°)	140
Pinion	F=female pinion
Seals material	= NBR

Rotary cylinders - Series 69

Product code: 69-125/140-F

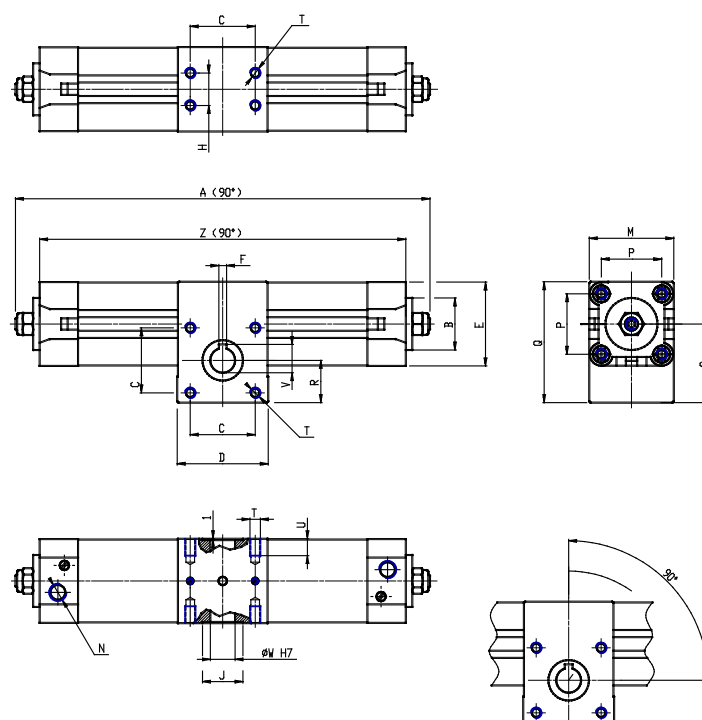

DIMENSIONS

A (mm)	622.3
B d11 (mm)	60
C (mm)	90
D (mm)	125
E (mm)	135.0
F (mm)	8
G (mm)	38
H (mm)	70
J (mm)	60
K (mm)	45
L (mm)	51
M (mm)	140
N	G1/2
P (mm)	110.0
Q (mm)	188.0
R (mm)	60.0
S (mm)	118.0
T	M12
U (mm)	20
V (mm)	31.3
W (mm)	28
Y	M10
X (mm)	22.0
Z (mm)	578.3