

Positioning feedback cylinders ISO 15552 - Series 6PF

Product code: 6PF3P050A0100

Datasheet creation date: 09/03/2025 22:50

Check the most updated document online [click here](#)



TECHNICAL DATA

Series	6PF
Diameter (mm)	50
Operation	3 = double-acting low friction, no cushion
Materials	P = chromed steel rod, anodized aluminum profile tube, NBR gaskets, zinc plated steel nuts and tie rods and NBR rod gasket
Stroke type	A = standard with lock nut for rod
Stroke (mm)	100
extended piston (mm)	0
Versions	-
Atex	No Atex

Positioning feedback cylinders ISO 15552 - Series 6PF

Product code: 6PF3P050A0100

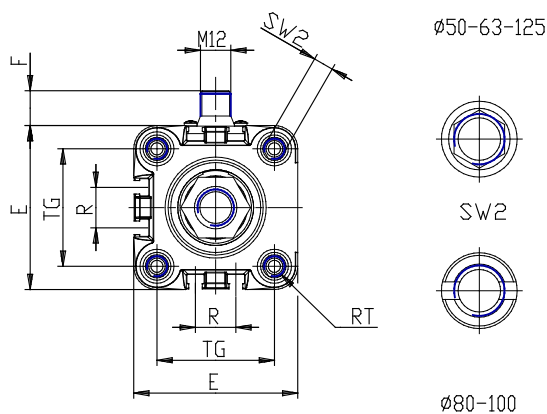
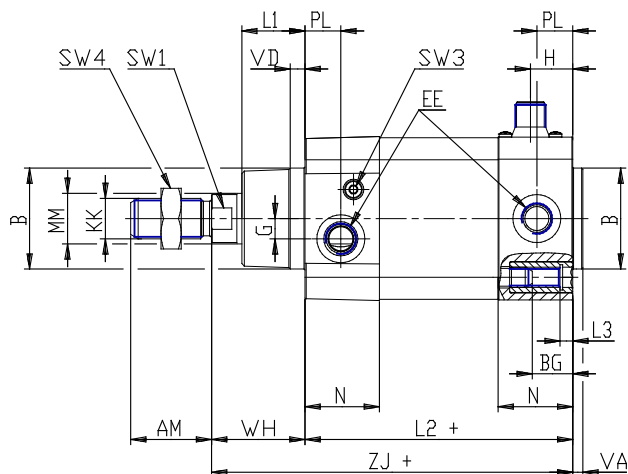

DIMENSIONS

MM (mm)	20
KK	M16x1,5
B (mm)	40
PL (mm)	15.0
L1 (mm)	25
AM (mm)	32
VA (mm)	4
EE	G1/4
WH (mm)	37
L2 (mm)	106
L3 (mm)	5
ZJ (mm)	143
VD (mm)	6
N (mm)	29.5
BG (mm)	16.0
RT	M8
F (mm)	14
G (mm)	8.0
H (mm)	17
TG (mm)	46.5
R (mm)	16
E (mm)	64.5
SW1 (mm)	17

SW2 (mm)	8
SW3 (mm)	3
SW4 (mm)	24
Cushion stroke (mm)	22