

## Positioning feedback cylinders ISO 15552 - Series 6PF

Product code: 6PF3P080A0500EX

Datasheet creation date: 09/03/2025 22:53

Check the most updated document online [click here](#)



### TECHNICAL DATA

<b>Series</b>	6PF
<b>Diameter (mm)</b>	80
<b>Operation</b>	3 = double-acting low friction, no cushion
<b>Materials</b>	P = chromed steel rod, anodized aluminum profile tube, NBR gaskets, zinc plated steel nuts and tie rods and NBR rod gasket
<b>Stroke type</b>	A = standard with lock nut for rod
<b>Stroke (mm)</b>	500
<b>extended piston (mm)</b>	0
<b>Versions</b>	-
<b>Atex</b>	Atex

## Positioning feedback cylinders ISO 15552 - Series 6PF

Product code: 6PF3P080A0500EX

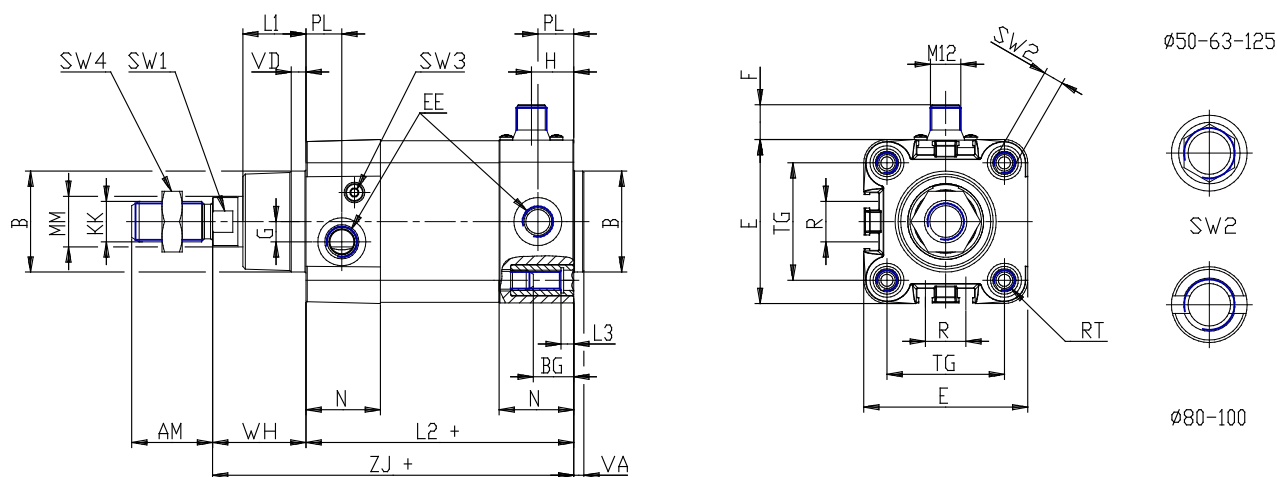

### DIMENSIONS

MM (mm)	25
KK	M20x1,5
B (mm)	45
PL (mm)	21.0
L1 (mm)	30
AM (mm)	40
VA (mm)	4
EE	G3/8
WH (mm)	46
L2 (mm)	128
L3 (mm)	0
ZJ (mm)	174
VD (mm)	7
N (mm)	36.0
BG (mm)	19.0
RT	M10
F (mm)	14
G (mm)	8.0
H (mm)	24
TG (mm)	72.0
R (mm)	30
E (mm)	93.0
SW1 (mm)	22

SW2 (mm)	10
SW3 (mm)	5
SW4 (mm)	30
Cushion stroke (mm)	25