

Positioning feedback cylinders ISO 15552 - Series 6PF

Product code: 6PF3P100A0400(80)

Datasheet creation date: 09/03/2025 21:52

Check the most updated document online [click here](#)



TECHNICAL DATA

Series	6PF
Diameter (mm)	100
Operation	3 = double-acting low friction, no cushion
Materials	P = chromed steel rod, anodized aluminum profile tube, NBR gaskets, zinc plated steel nuts and tie rods and NBR rod gasket
Stroke type	A = standard with lock nut for rod
Stroke (mm)	400
extended piston (mm)	80
Versions	-
Atex	No Atex

Positioning feedback cylinders ISO 15552 - Series 6PF

Product code: 6PF3P100A0400(80)

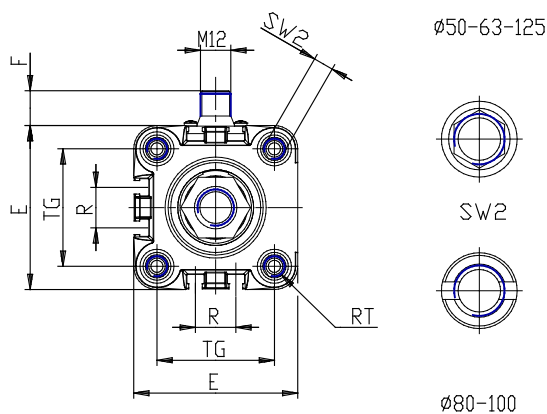
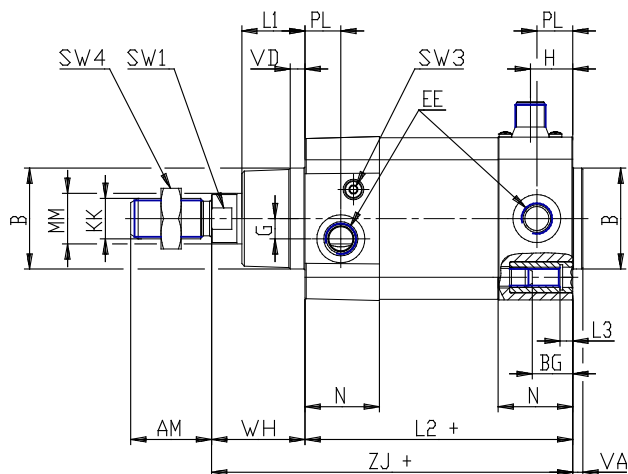

DIMENSIONS

MM (mm)	25
KK	M20x1,5
B (mm)	55
PL (mm)	23.0
L1 (mm)	35
AM (mm)	40
VA (mm)	4
EE	G1/2
WH (mm)	51
L2 (mm)	138
L3 (mm)	0
ZJ (mm)	189
VD (mm)	7
N (mm)	38.5
BG (mm)	19.5
RT	M10
F (mm)	14
G (mm)	8.0
H (mm)	26
TG (mm)	89.0
R (mm)	40
E (mm)	110.0
SW1 (mm)	22

SW2 (mm)	10
SW3 (mm)	5
SW4 (mm)	30
Cushion stroke (mm)	25