

## Positioning feedback cylinders ISO 15552 - Series 6PF

Product code: 6PF3P125A0150

Datasheet creation date: 09/03/2025 22:49

Check the most updated document online [click here](#)



### TECHNICAL DATA

<b>Series</b>	6PF
<b>Diameter (mm)</b>	125
<b>Operation</b>	3 = double-acting low friction, no cushion
<b>Materials</b>	P = chromed steel rod, anodized aluminum profile tube, NBR gaskets, zinc plated steel nuts and tie rods and NBR rod gasket
<b>Stroke type</b>	A = standard with lock nut for rod
<b>Stroke (mm)</b>	150
<b>extended piston (mm)</b>	0
<b>Versions</b>	-
<b>Atex</b>	No Atex

## Positioning feedback cylinders ISO 15552 - Series 6PF

Product code: 6PF3P125A0150

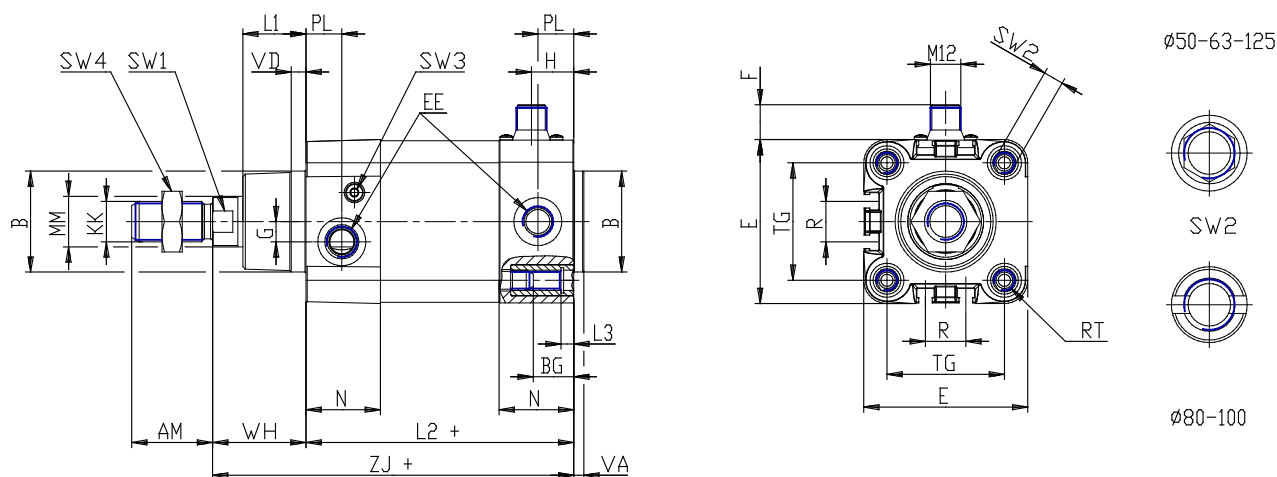

### DIMENSIONS

MM (mm)	32
KK	M27x2
B (mm)	60
PL (mm)	23.5
L1 (mm)	42
AM (mm)	54
VA (mm)	6
EE	G1/2
WH (mm)	65
L2 (mm)	160
L3 (mm)	0
ZJ (mm)	225
VD (mm)	8
N (mm)	43.0
BG (mm)	23.0
RT	M12
F (mm)	14
G (mm)	10.5
H (mm)	30
TG (mm)	110.0
R (mm)	50
E (mm)	135.0
SW1 (mm)	27

SW2 (mm)	12
SW3 (mm)	4
SW4 (mm)	41
Cushion stroke (mm)	43