

Mod. 8432 - Series 8000 fittings

Product code: 8432 8-1/4

Datasheet creation date: 10/03/2025 09:04

Check the most updated document online [click here](#)



■ TECHNICAL DATA

Mod.	8432 8-1/4
------	------------

Mod. 8432 - Series 8000 fittings

Product code: 8432 8-1/4

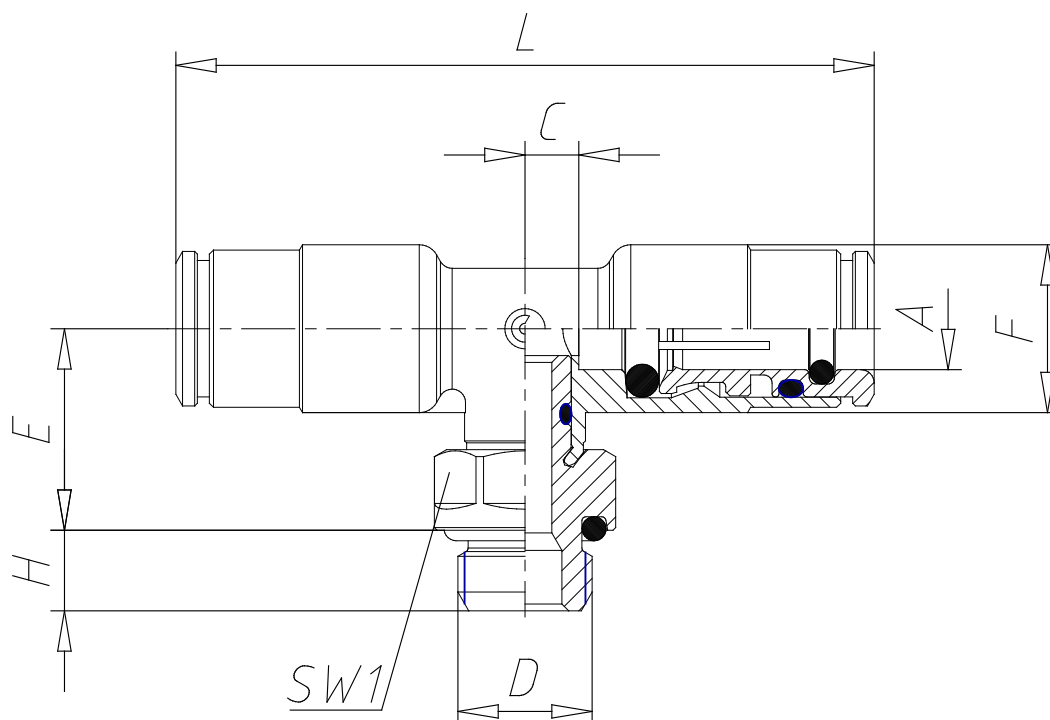

DIMENSIONS

A (mm)	8
D	G 1/4
C (mm)	5
E (mm)	17.0
F (mm)	14.5
H (mm)	7
L (mm)	58
SW1 (mm)	15