

End block with front outlets (VDMA 24345) - Series 9

Product code: 901-N1

Datasheet creation date: 07/03/2025 16:18

Check the most updated document online [click here](#)



TECHNICAL DATA

Mod.	901-N1
Size	1

End block with front outlets (VDMA 24345) - Series 9

Product code: 901-N1

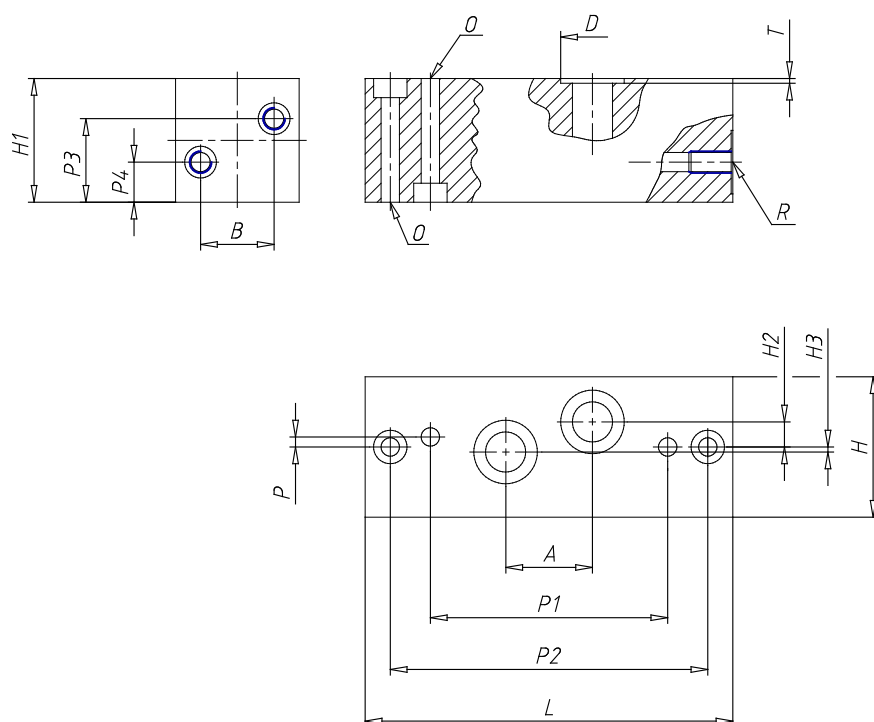

DIMENSIONS

A (mm)	26
B (mm)	22
D (mm)	19
H (mm)	42
H1 (mm)	37
H2 (mm)	7.5
H3 (mm)	1.5
L (mm)	110
O (mm)	5.5
P (mm)	3
P1 (mm)	71
P2 (mm)	95
P3 (mm)	25
P4 (mm)	12
R	G1/4
T (mm)	1.4