

Stainless steel minicylinders CETOP RP52-P DIN/ISO 6432 - Series 94 e 95

Product code: 94N2A20A100V

Datasheet creation date: 07/03/2025 17:26

Check the most updated document online [click here](#)



TECHNICAL DATA

Series	94
Diameter (mm)	20
Version	N = standard
Operation	2 = double-acting (front and rear cushions)
Materials	A = stainless steel AISI 316 (SS 2343), joints NBR
Construction	A = standard
rod seals viton	V = rod seals in viton
Stroke type	standard
Stroke (mm)	100

Stainless steel minicylinders CETOP RP52-P DIN/ISO 6432 - Series 94 e 95

Product code: 94N2A20A100V

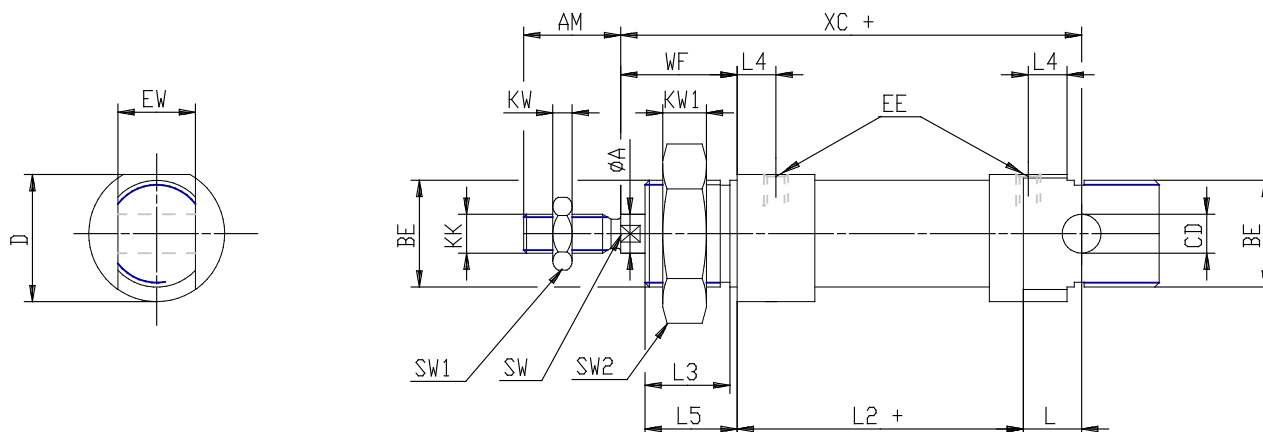

DIMENSIONS

A (mm)	8
AM (mm)	20
BE	M22x1,5
Ø CD (mm)	8
D (mm)	26.2
EE	G1\8
EW (mm)	16
KK	M8x1,25
KW (mm)	5
(mm)	5
L (mm)	12
L1 (mm)	116
L2 (mm)	59
L3 (mm)	17.5
L4 (mm)	8.0
L5 (mm)	19
SW (mm)	7
WF (mm)	24
XC (mm)	95