

## Stainless steel minicylinders CETOP RP52-P DIN/ISO 6432 - Series 94 e 95

Product code: 94N2A20A180

Datasheet creation date: 07/03/2025 17:27

Check the most updated document online [click here](#)



### TECHNICAL DATA

<b>Series</b>	94
<b>Diameter (mm)</b>	20
<b>Version</b>	N = standard
<b>Operation</b>	2 = double-acting (front and rear cushions)
<b>Materials</b>	A = stainless steel AISI 316 (SS 2343), joints NBR
<b>Construction</b>	A = standard
<b>rod seals viton</b>	-
<b>Stroke type</b>	variable
<b>Stroke (mm)</b>	180

## Stainless steel minicylinders CETOP RP52-P DIN/ISO 6432 - Series 94 e 95

Product code: 94N2A20A180

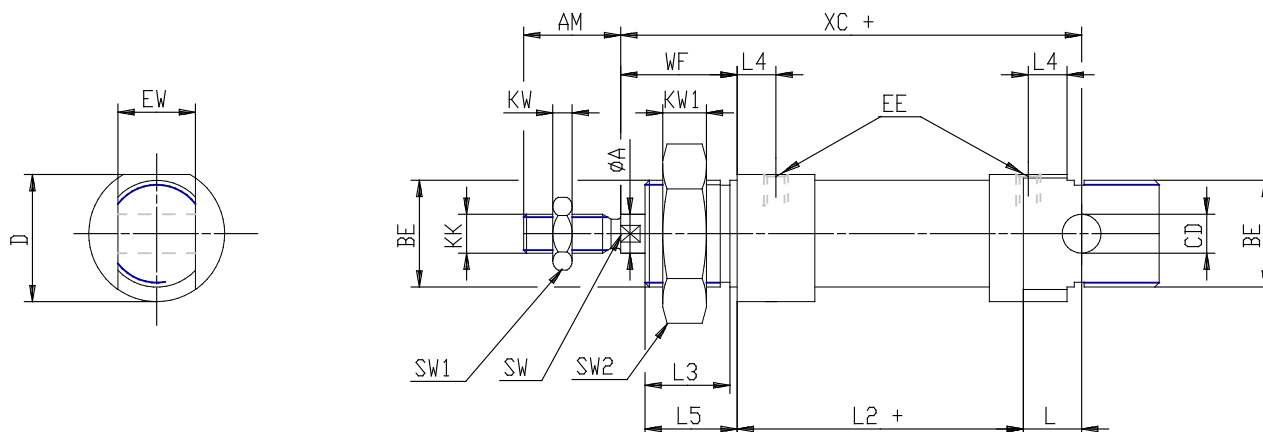

### DIMENSIONS

<b>A (mm)</b>	8
<b>AM (mm)</b>	20
<b>BE</b>	M22x1,5
<b>Ø CD (mm)</b>	8
<b>D (mm)</b>	26.2
<b>EE</b>	G1\8
<b>EW (mm)</b>	16
<b>KK</b>	M8x1,25
<b>KW (mm)</b>	5
<b>(mm)</b>	5
<b>L (mm)</b>	12
<b>L1 (mm)</b>	116
<b>L2 (mm)</b>	59
<b>L3 (mm)</b>	17.5
<b>L4 (mm)</b>	8.0
<b>L5 (mm)</b>	19
<b>SW (mm)</b>	7
<b>WF (mm)</b>	24
<b>XC (mm)</b>	95