

Stainless steel minicylinders CETOP RP52-P DIN/ISO 6432 - Series 94 e 95

Product code: 94N2V16A040

Datasheet creation date: 07/03/2025 17:25

Check the most updated document online [click here](#)



TECHNICAL DATA

Series	94
Diameter (mm)	16
Version	N = standard
Operation	2 = double-acting (front and rear cushions)
Materials	V = stainless steel AISI 316 (SS 2343), all joints in viton
Construction	A = standard
rod seals viton	-
Stroke type	standard
Stroke (mm)	40

Stainless steel minicylinders CETOP RP52-P DIN/ISO 6432 - Series 94 e 95

Product code: 94N2V16A040

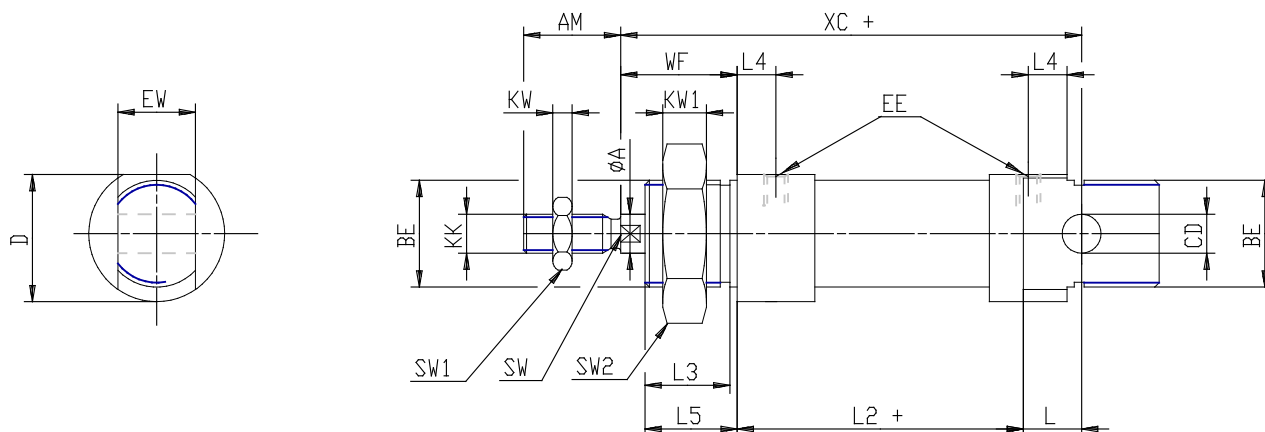

DIMENSIONS

A (mm)	6
AM (mm)	16
BE	M16x1,5
Ø CD (mm)	6
D (mm)	21.2
EE	M5
EW (mm)	12
KK	M6x1
KW (mm)	4
(mm)	5
L (mm)	9
L1 (mm)	100
L2 (mm)	51
L3 (mm)	14.0
L4 (mm)	5.5
L5 (mm)	15
SW (mm)	5
WF (mm)	22
XC (mm)	82