

5/2-way solenoid valves, ISO 1, ISO 2, ISO 3, monostable - Series 9

Product code: 952-000-P15-23

Datasheet creation date: 10/03/2025 12:04

Check the most updated document online [click here](#)

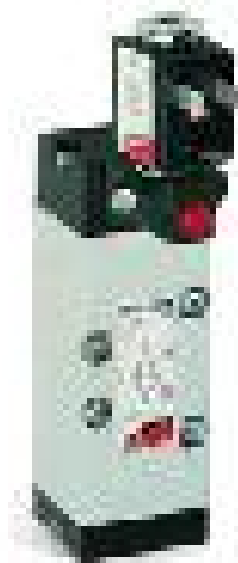

■ TECHNICAL DATA

Mod.	952-000-P15-23
------	----------------

5/2-way solenoid valves, ISO 1, ISO 2, ISO 3, monostable - Series 9

Product code: 952-000-P15-23

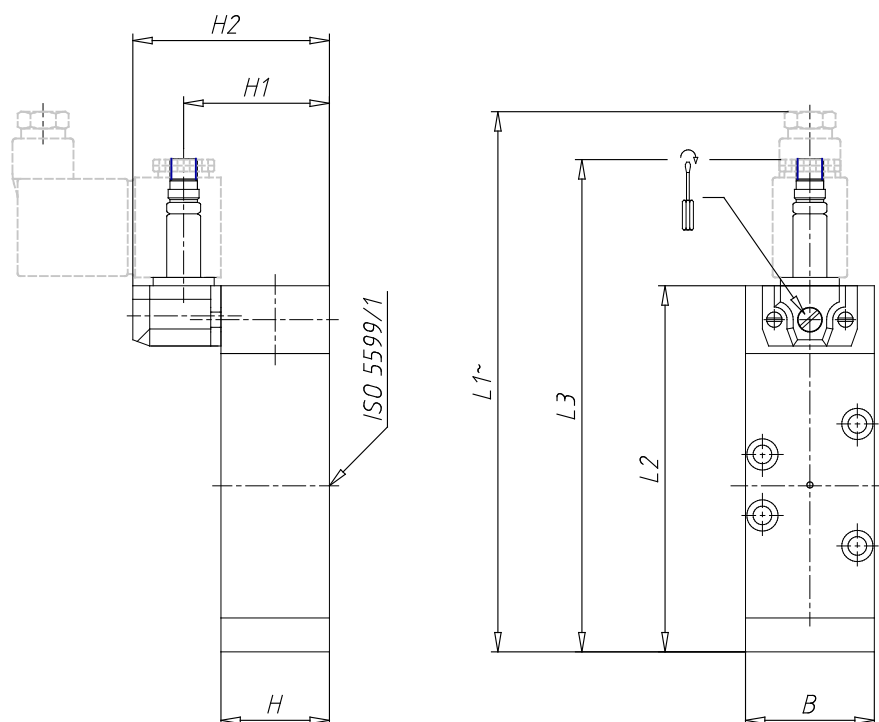

DIMENSIONS

Size ISO	2
B (mm)	51
L1 (mm)	173
L2 (mm)	128
L3 (mm)	166
H (mm)	33
H1 (mm)	44.5
H2 (mm)	60