

Stainless steel minicylinders CETOP RP52-P DIN/ISO 6432 - Series 94 e 95

Product code: 95N2A25A040V

Datasheet creation date: 07/03/2025 17:30

Check the most updated document online [click here](#)



TECHNICAL DATA

Series	95
Diameter (mm)	25
Version	N = standard
Operation	2 = double-acting (front and rear cushions)
Materials	A = stainless steel AISI 316 (SS 2343), joints NBR
Construction	A = standard
rod seals viton	V = rod seals in viton
Stroke type	standard
Stroke (mm)	40

Stainless steel minicylinders CETOP RP52-P DIN/ISO 6432 - Series 94 e 95

Product code: 95N2A25A040V

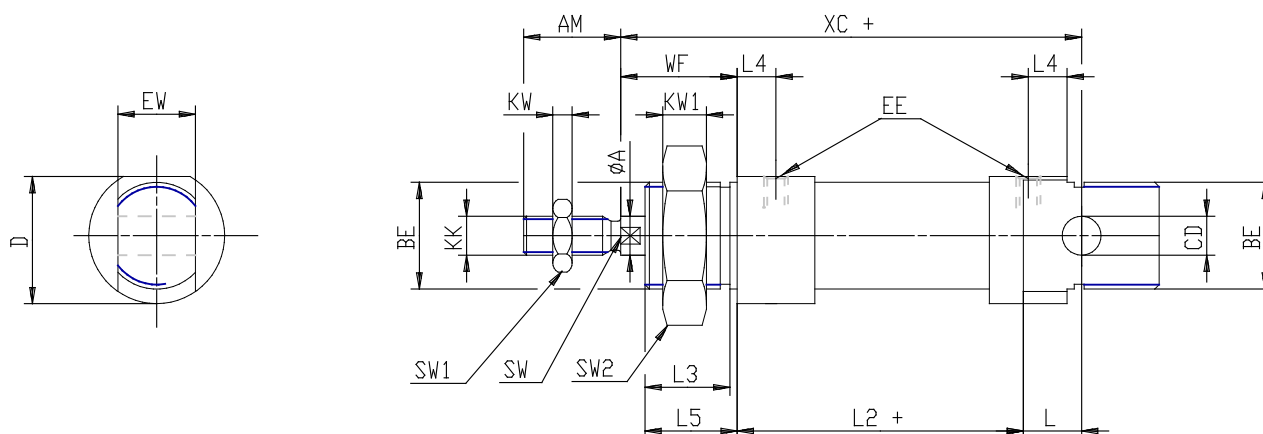

DIMENSIONS

A (mm)	10
AM (mm)	22
BE	M22x1,5
Ø CD (mm)	8
D (mm)	32.5
EE	G1\8
EW (mm)	16
KK	M10x1,25
KW (mm)	6
(mm)	5
L (mm)	12
L1 (mm)	125
L2 (mm)	64
L3 (mm)	18.5
L4 (mm)	7.5
L5 (mm)	20
SW (mm)	8
WF (mm)	28
XC (mm)	104