

• - Series 97

Product code: 97M1A050A0050

Datasheet creation date: 07/03/2025 17:39

Check the most updated document online [click here](#)



TECHNICAL DATA

Series (mm)	97
Diameter (mm)	50
Version (mm)	M = rear male hinge
Operation (mm)	1=single-acting (front spring)
Materials (mm)	A = stainless steel AISI 304 - PU seals
Construction (mm)	A = standard (locking ring for end cap V + lock nut for rod U)
Stroke type	standard
Stroke (mm)	50
rod seal in FKM (mm)	-

• - Series 97

Product code: 97M1A050A0050

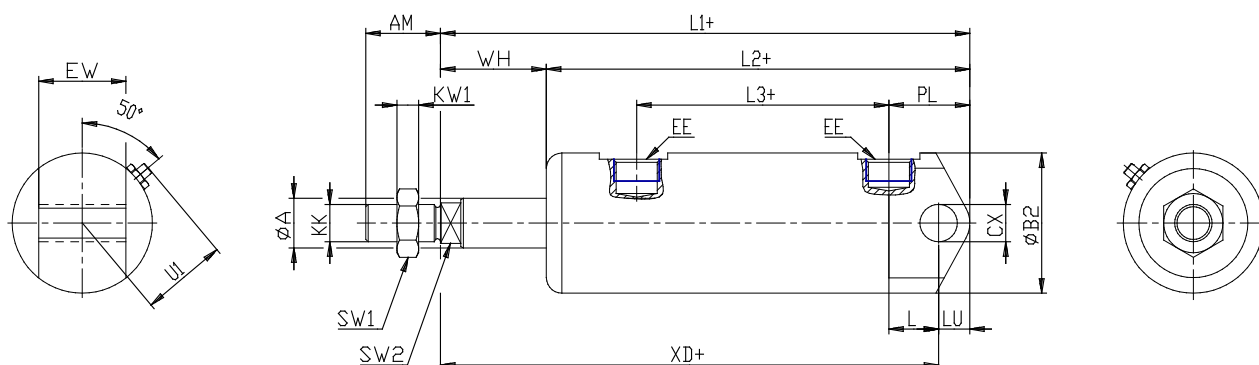

DIMENSIONS

Ø A (mm)	20
AM (mm)	32
Ø B (mm)	-
Ø B2 (mm)	55
CB (mm)	-
CX (mm)	12
EE (mm)	G 1/4
EP (mm)	-
EX (mm)	-
EW (mm)	32
F (mm)	6
G (mm)	53
KK (mm)	M16X1,5
PL (mm)	32.0
SW (mm)	-
SW1 (mm)	24
KW1 (mm)	8
SW2 (mm)	17
U1 (mm)	33
WH	37.0
L1	182.0
L2 (mm)	145.0
L3 (mm)	82

L4	-
L7 (mm)	-
L (mm)	21
LT (mm)	-
LU (mm)	12
KW (mm)	-
Ø KV (mm)	-
XD (mm)	195
XG (mm)	-
TD (mm)	-
TL (mm)	-
UB (mm)	-
UT (mm)	-
ZC (mm)	-
Z (mm)	-