

• - Series 97

Product code: 97M2A032A0300

Datasheet creation date: 07/03/2025 17:33

Check the most updated document online [click here](#)



TECHNICAL DATA

Series (mm)	97
Diameter (mm)	32
Version (mm)	M = rear male hinge
Operation (mm)	2 = double-acting (front and rear cushions)
Materials (mm)	A = stainless steel AISI 304 - PU seals
Construction (mm)	A = standard (locking ring for end cap V + lock nut for rod U)
Stroke type	standard
Stroke (mm)	300
rod seal in FKM (mm)	-

• - Series 97

Product code: 97M2A032A0300

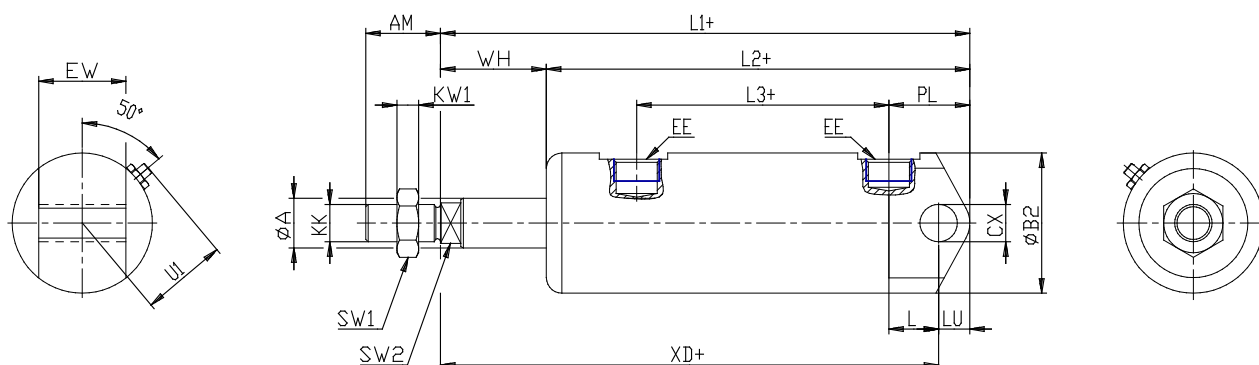

DIMENSIONS

Ø A (mm)	12
AM (mm)	22
Ø B (mm)	-
Ø B2 (mm)	36
CB (mm)	-
CX (mm)	10
EE (mm)	G 1/8
EP (mm)	-
EX (mm)	-
EW (mm)	26
F (mm)	5
G (mm)	38
KK (mm)	M10X1,25
PL (mm)	23.0
SW (mm)	-
SW1 (mm)	17
KW1 (mm)	6
SW2 (mm)	10
U1 (mm)	23
WH	26.0
L1	151.0
L2 (mm)	125.0
L3 (mm)	76

L4	-
L7 (mm)	-
L (mm)	13
LT (mm)	-
LU (mm)	9
KW (mm)	-
Ø KV (mm)	-
XD (mm)	167
XG (mm)	-
TD (mm)	-
TL (mm)	-
UB (mm)	-
UT (mm)	-
ZC (mm)	-
Z (mm)	-