

• - Series 97

Product code: 97M2A040A0050

Datasheet creation date: 07/03/2025 17:36

Check the most updated document online [click here](#)



**TECHNICAL DATA**

<b>Series (mm)</b>	97
<b>Diameter (mm)</b>	40
<b>Version (mm)</b>	M = rear male hinge
<b>Operation (mm)</b>	2 = double-acting (front and rear cushions)
<b>Materials (mm)</b>	A = stainless steel AISI 304 - PU seals
<b>Construction (mm)</b>	A = standard (locking ring for end cap V + lock nut for rod U)
<b>Stroke type</b>	standard
<b>Stroke (mm)</b>	50
<b>rod seal in FKM (mm)</b>	-

• - Series 97

Product code: 97M2A040A0050

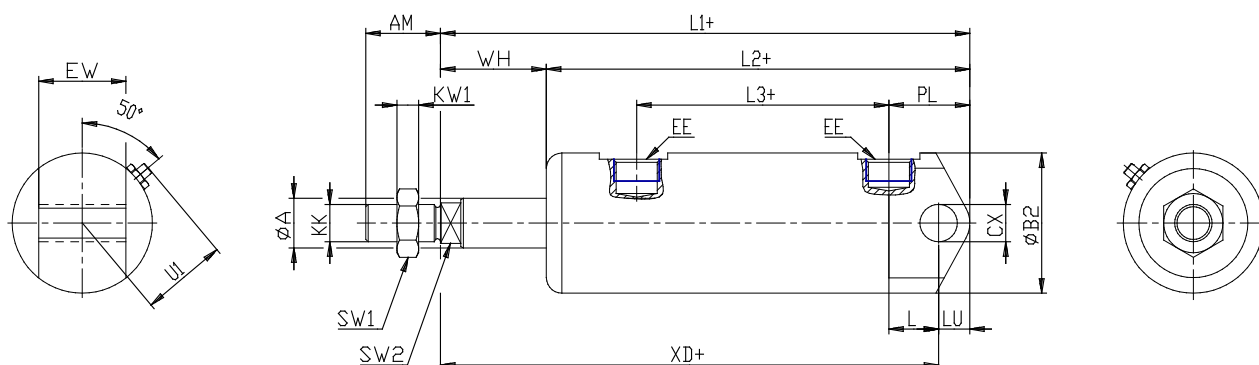

**DIMENSIONS**

Ø A (mm)	16
AM (mm)	24
Ø B (mm)	-
Ø B2 (mm)	45
CB (mm)	-
CX (mm)	12
EE (mm)	G 1/4
EP (mm)	-
EX (mm)	-
EW (mm)	28
F (mm)	6
G (mm)	50
KK (mm)	M12X1,25
PL (mm)	26.0
SW (mm)	-
SW1 (mm)	19
KW1 (mm)	7
SW2 (mm)	13
U1 (mm)	27
WH	34.0
L1	170.0
L2 (mm)	136.0
L3 (mm)	81

L4	-
L7 (mm)	-
L (mm)	16
LT (mm)	-
LU (mm)	10
KW (mm)	-
Ø KV (mm)	-
XD (mm)	185
XG (mm)	-
TD (mm)	-
TL (mm)	-
UB (mm)	-
UT (mm)	-
ZC (mm)	-
Z (mm)	-