

• - Series 97

Product code: 97M2A040A0350

Datasheet creation date: 07/03/2025 17:37

Check the most updated document online [click here](#)



TECHNICAL DATA

Series (mm)	97
Diameter (mm)	40
Version (mm)	M = rear male hinge
Operation (mm)	2 = double-acting (front and rear cushions)
Materials (mm)	A = stainless steel AISI 304 - PU seals
Construction (mm)	A = standard (locking ring for end cap V + lock nut for rod U)
Stroke type	variable
Stroke (mm)	350
rod seal in FKM (mm)	-

• - Series 97

Product code: 97M2A040A0350

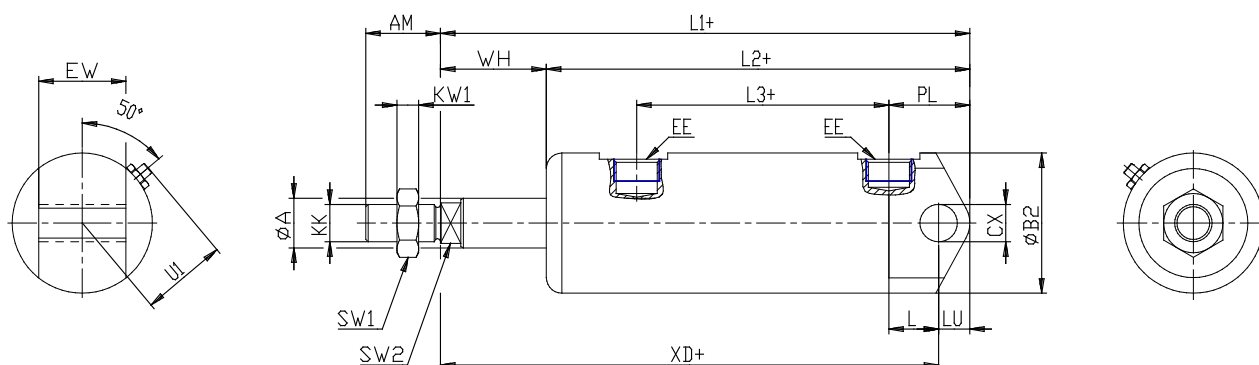

DIMENSIONS

Ø A (mm)	16
AM (mm)	24
Ø B (mm)	-
Ø B2 (mm)	45
CB (mm)	-
CX (mm)	12
EE (mm)	G 1/4
EP (mm)	-
EX (mm)	-
EW (mm)	28
F (mm)	6
G (mm)	50
KK (mm)	M12X1,25
PL (mm)	26.0
SW (mm)	-
SW1 (mm)	19
KW1 (mm)	7
SW2 (mm)	13
U1 (mm)	27
WH	34.0
L1	170.0
L2 (mm)	136.0
L3 (mm)	81

L4	-
L7 (mm)	-
L (mm)	16
LT (mm)	-
LU (mm)	10
KW (mm)	-
Ø KV (mm)	-
XD (mm)	185
XG (mm)	-
TD (mm)	-
TL (mm)	-
UB (mm)	-
UT (mm)	-
ZC (mm)	-
Z (mm)	-