

• - Series 97

Product code: 97M2A050A0025

Datasheet creation date: 07/03/2025 17:39

Check the most updated document online [click here](#)



**TECHNICAL DATA**

<b>Series (mm)</b>	97
<b>Diameter (mm)</b>	50
<b>Version (mm)</b>	M = rear male hinge
<b>Operation (mm)</b>	2 = double-acting (front and rear cushions)
<b>Materials (mm)</b>	A = stainless steel AISI 304 - PU seals
<b>Construction (mm)</b>	A = standard (locking ring for end cap V + lock nut for rod U)
<b>Stroke type</b>	standard
<b>Stroke (mm)</b>	25
<b>rod seal in FKM (mm)</b>	-

• - Series 97

Product code: 97M2A050A0025

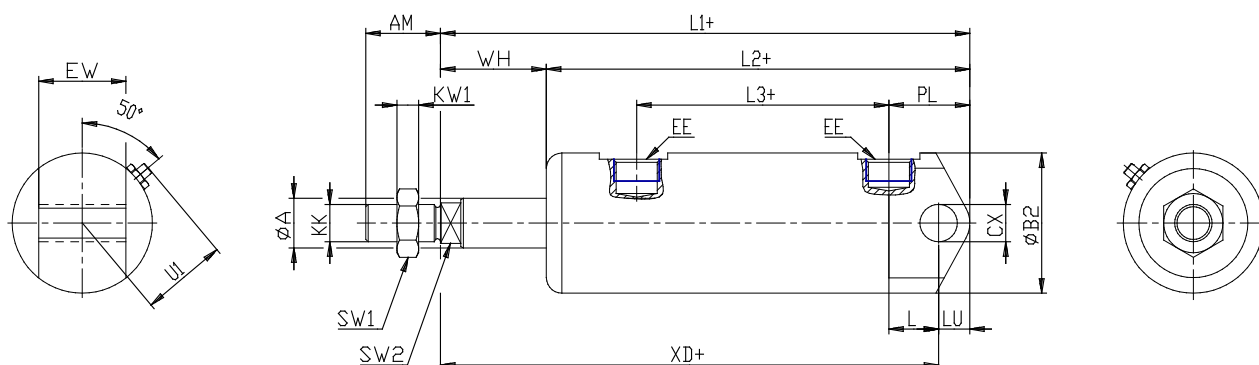

**DIMENSIONS**

Ø A (mm)	20
AM (mm)	32
Ø B (mm)	-
Ø B2 (mm)	55
CB (mm)	-
CX (mm)	12
EE (mm)	G 1/4
EP (mm)	-
EX (mm)	-
EW (mm)	32
F (mm)	6
G (mm)	53
KK (mm)	M16X1,5
PL (mm)	32.0
SW (mm)	-
SW1 (mm)	24
KW1 (mm)	8
SW2 (mm)	17
U1 (mm)	33
WH	37.0
L1	182.0
L2 (mm)	145.0
L3 (mm)	82

L4	-
L7 (mm)	-
L (mm)	21
LT (mm)	-
LU (mm)	12
KW (mm)	-
Ø KV (mm)	-
XD (mm)	195
XG (mm)	-
TD (mm)	-
TL (mm)	-
UB (mm)	-
UT (mm)	-
ZC (mm)	-
Z (mm)	-