

• - Series 97

Product code: 97M2A063A0100

Datasheet creation date: 07/03/2025 17:42

Check the most updated document online [click here](#)



TECHNICAL DATA

Series (mm)	97
Diameter (mm)	63
Version (mm)	M = rear male hinge
Operation (mm)	2 = double-acting (front and rear cushions)
Materials (mm)	A = stainless steel AISI 304 - PU seals
Construction (mm)	A = standard (locking ring for end cap V + lock nut for rod U)
Stroke type	standard
Stroke (mm)	100
rod seal in FKM (mm)	-

• - Series 97

Product code: 97M2A063A0100

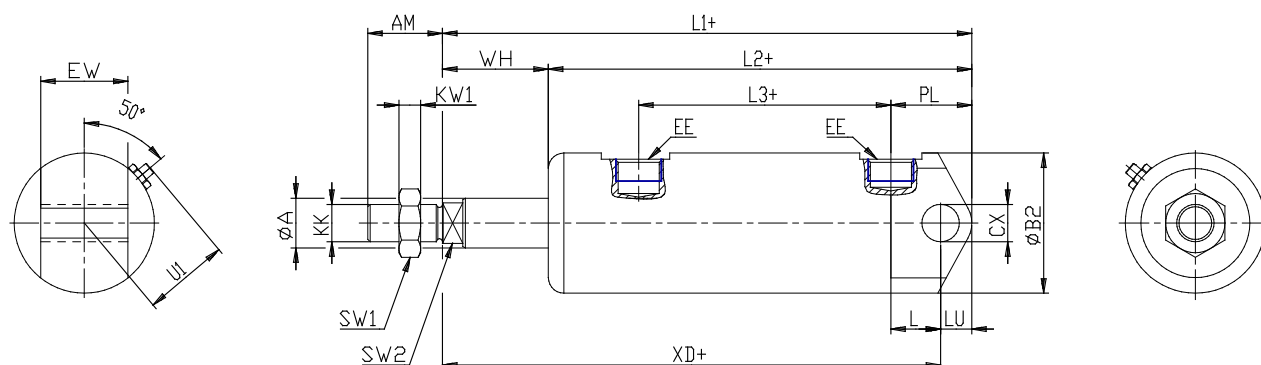

DIMENSIONS

Ø A (mm)	20
AM (mm)	32
Ø B (mm)	-
Ø B2 (mm)	68
CB (mm)	-
CX (mm)	16
EE (mm)	G 3/8
EP (mm)	-
EX (mm)	-
EW (mm)	40
F (mm)	6
G (mm)	53
KK (mm)	M16X1,5
PL (mm)	29.5
SW (mm)	-
SW1 (mm)	24
KW1 (mm)	8
SW2 (mm)	17
U1 (mm)	40
WH	50.0
L1	202.0
L2 (mm)	152.0
L3 (mm)	95

L4	-
L7 (mm)	-
L (mm)	21
LT (mm)	-
LU (mm)	12
KW (mm)	-
Ø KV (mm)	-
XD (mm)	215
XG (mm)	-
TD (mm)	-
TL (mm)	-
UB (mm)	-
UT (mm)	-
ZC (mm)	-
Z (mm)	-