

• - Series 97

Product code: 97S2A032A0080

Datasheet creation date: 07/03/2025 17:33

Check the most updated document online [click here](#)



**TECHNICAL DATA**

<b>Series (mm)</b>	97
<b>Diameter (mm)</b>	32
<b>Version (mm)</b>	S = articulated rear male hinge
<b>Operation (mm)</b>	2 = double-acting (front and rear cushions)
<b>Materials (mm)</b>	A = stainless steel AISI 304 - PU seals
<b>Construction (mm)</b>	A = standard (locking ring for end cap V + lock nut for rod U)
<b>Stroke type</b>	standard
<b>Stroke (mm)</b>	80
<b>rod seal in FKM (mm)</b>	-

• - Series 97

Product code: 97S2A032A0080

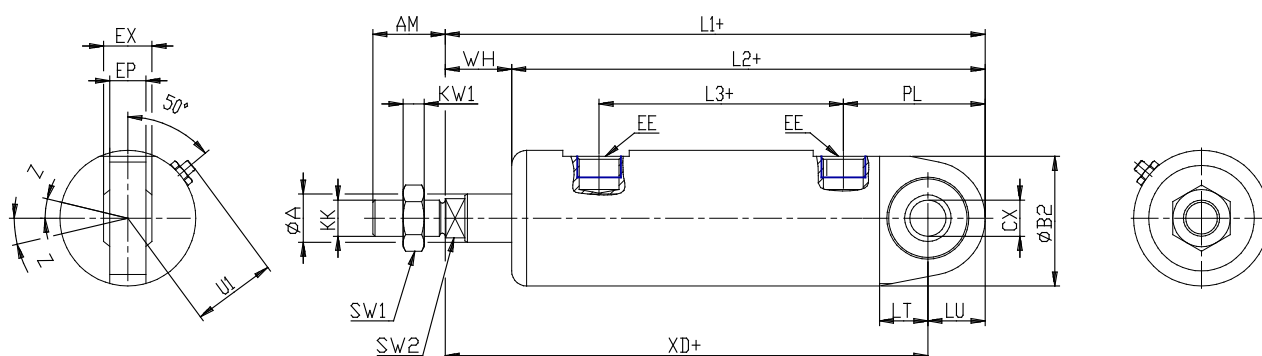

**DIMENSIONS**

Ø A (mm)	12
AM (mm)	22
Ø B (mm)	-
Ø B2 (mm)	36
CB (mm)	-
CX (mm)	10
EE (mm)	G 1/8
EP (mm)	10.5
EX (mm)	14
EW (mm)	-
F (mm)	5
G (mm)	38
KK (mm)	M10X1,25
PL (mm)	37.0
SW (mm)	-
SW1 (mm)	17
KW1 (mm)	6
SW2 (mm)	10
U1 (mm)	23
WH	18.0
L1	157.0
L2 (mm)	139.0
L3 (mm)	76

L4	-
L7 (mm)	-
L (mm)	-
LT (mm)	13
LU (mm)	15
KW (mm)	-
Ø KV (mm)	-
XD (mm)	167
XG (mm)	-
TD (mm)	-
TL (mm)	-
UB (mm)	-
UT (mm)	-
ZC (mm)	-
Z (mm)	13