

• - Series 97

Product code: 97S2A050A0650

Datasheet creation date: 07/03/2025 17:40

Check the most updated document online [click here](#)



TECHNICAL DATA

Series (mm)	97
Diameter (mm)	50
Version (mm)	S = articulated rear male hinge
Operation (mm)	2 = double-acting (front and rear cushions)
Materials (mm)	A = stainless steel AISI 304 - PU seals
Construction (mm)	A = standard (locking ring for end cap V + lock nut for rod U)
Stroke type	variable
Stroke (mm)	650
rod seal in FKM (mm)	-

• - Series 97

Product code: 97S2A050A0650

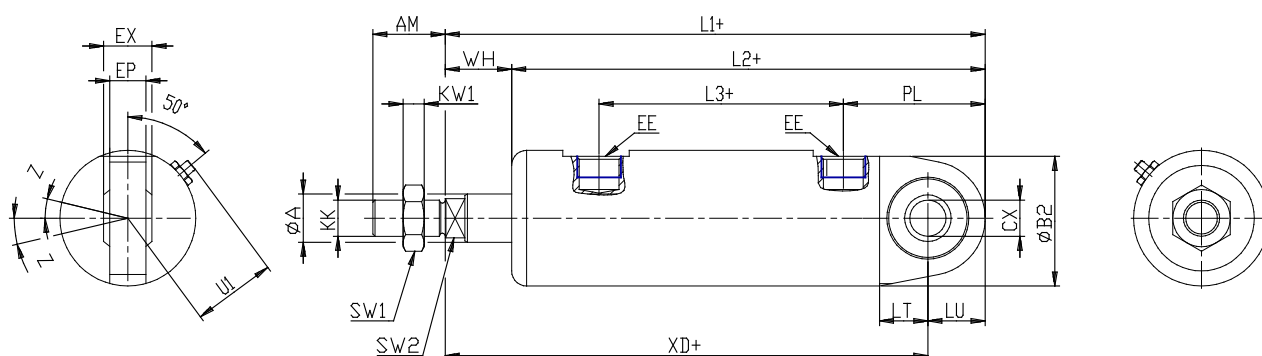

DIMENSIONS

Ø A (mm)	20
AM (mm)	32
Ø B (mm)	-
Ø B2 (mm)	55
CB (mm)	-
CX (mm)	16
EE (mm)	G 1/4
EP (mm)	15
EX (mm)	21
EW (mm)	-
F (mm)	6
G (mm)	53
KK (mm)	M16X1,5
PL (mm)	49.0
SW (mm)	-
SW1 (mm)	24
KW1 (mm)	8
SW2 (mm)	17
U1 (mm)	33
WH	28.5
L1	190.5
L2 (mm)	162.0
L3 (mm)	82

L4	-
L7 (mm)	-
L (mm)	-
LT (mm)	21
LU (mm)	20.5
KW (mm)	-
Ø KV (mm)	-
XD (mm)	195
XG (mm)	-
TD (mm)	-
TL (mm)	-
UB (mm)	-
UT (mm)	-
ZC (mm)	-
Z (mm)	15