

kit for axial connection - Mod. AM

Product code: AM-5E-50-0024

Datasheet creation date: 07/03/2025 15:39

Check the most updated document online [click here](#)

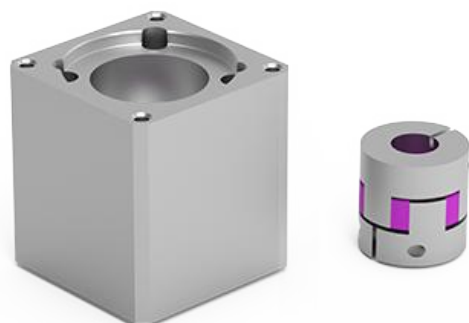

TECHNICAL DATA

Mod.	AM-5E-50-0024
Size (mm)	50
Protection	IP40
Weight (g)	440
Nominal torque (Nm)	9.0
Maximum torque (Nm)	18
Efficiency	0.78

kit for axial connection - Mod. AM

Product code: AM-5E-50-0024

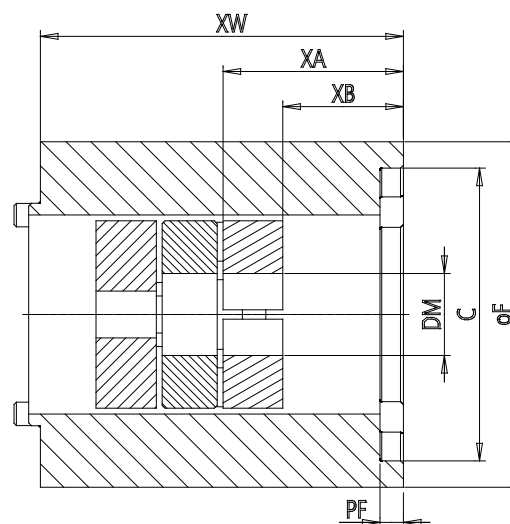
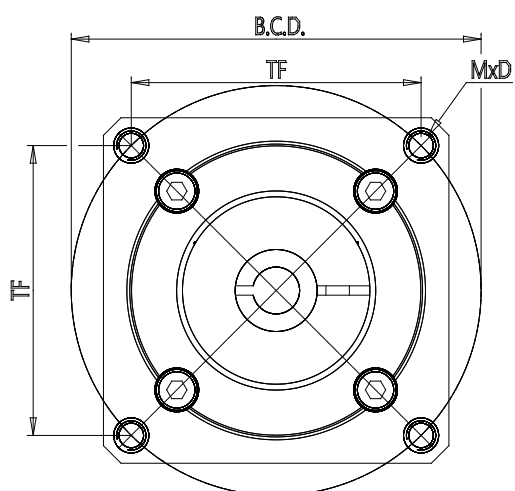

DIMENSIONS

C (mm)	38.1
DM (mm)	8
BCD (mm)	0
TF (mm)	47.1
MxD (mm)	M4x10
PF (mm)	3.0
F (mm)	59
XA (mm)	12.0
XB (mm)	20.5
XW (mm)	52.0
J (Kg*mm ²)	2