

kit for axial connection - Mod. AM

Product code: AM-5E-50-0100

Datasheet creation date: 07/03/2025 15:39

Check the most updated document online [click here](#)

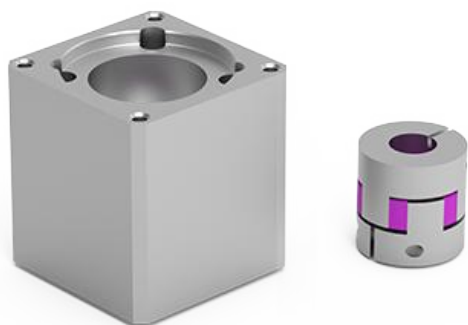

TECHNICAL DATA

Mod.	AM-5E-50-0100
Size (mm)	50
Protection	IP40
Weight (g)	310
Nominal torque (Nm)	9.0
Maximum torque (Nm)	18
Efficiency	0.78

kit for axial connection - Mod. AM

Product code: AM-5E-50-0100

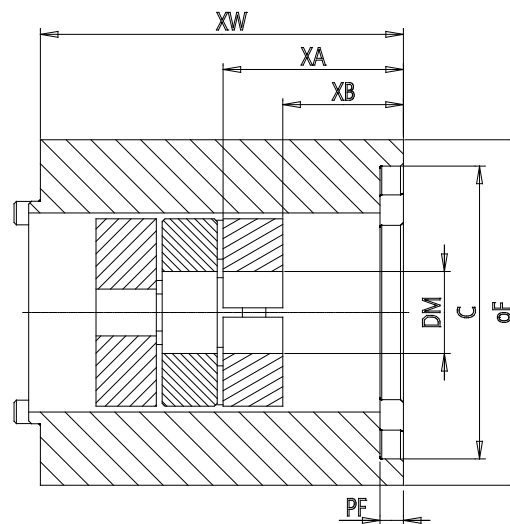
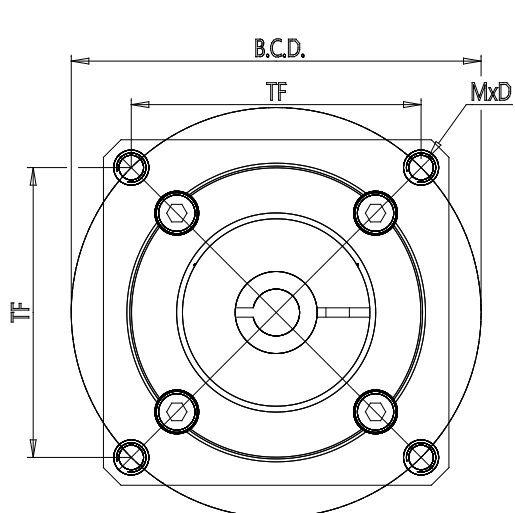

DIMENSIONS

C (mm)	30.0
DM (mm)	8
BCD (mm)	45
TF (mm)	0.0
MxD (mm)	M3x8
PF (mm)	6.5
F (mm)	49
XA (mm)	16.0
XB (mm)	25.0
XW (mm)	56.0
J (Kg*mm²)	2