

Kit for axial connection - Mod. AM

Product code: AM-6E-100-1000P

Datasheet creation date: 07/03/2025 15:43

Check the most updated document online [click here](#)



TECHNICAL DATA

Mod.	AM-6E-100-1000P
------	-----------------

Kit for axial connection - Mod. AM

Product code: AM-6E-100-1000P

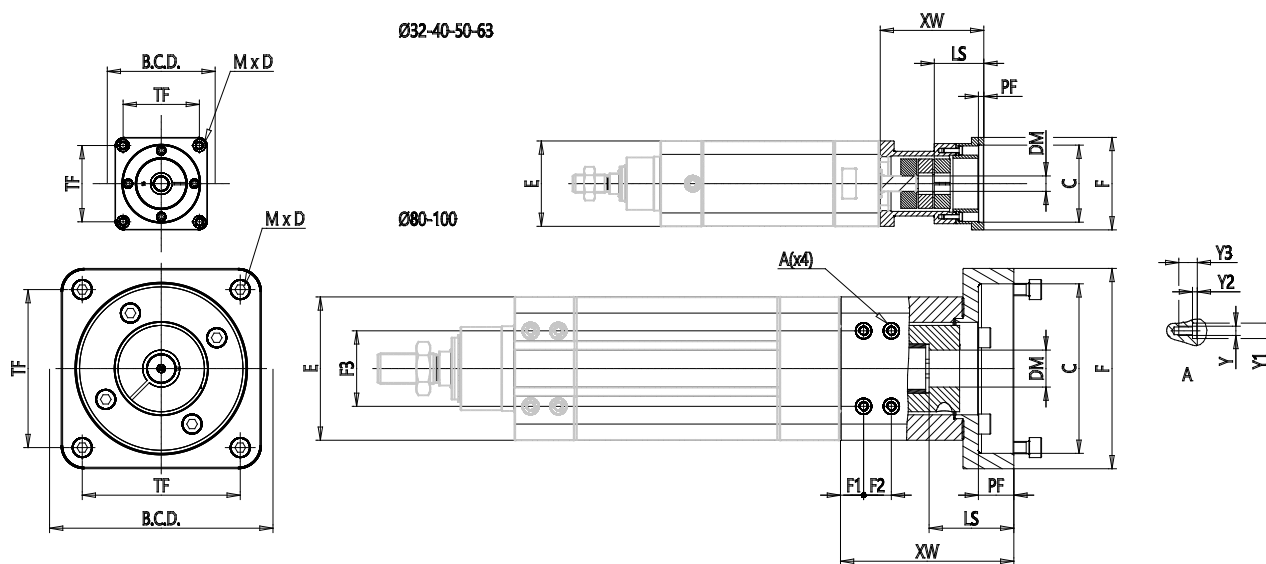

DIMENSIONS

E (mm)	115.0
Weight (g)	3465