

Kit for axial connection - Mod. AM

Product code: AM-6E-32-0023P

Datasheet creation date: 07/03/2025 15:43

Check the most updated document online [click here](#)



TECHNICAL DATA

Mod.	AM-6E-32-0023P
------	----------------

Kit for axial connection - Mod. AM

Product code: AM-6E-32-0023P

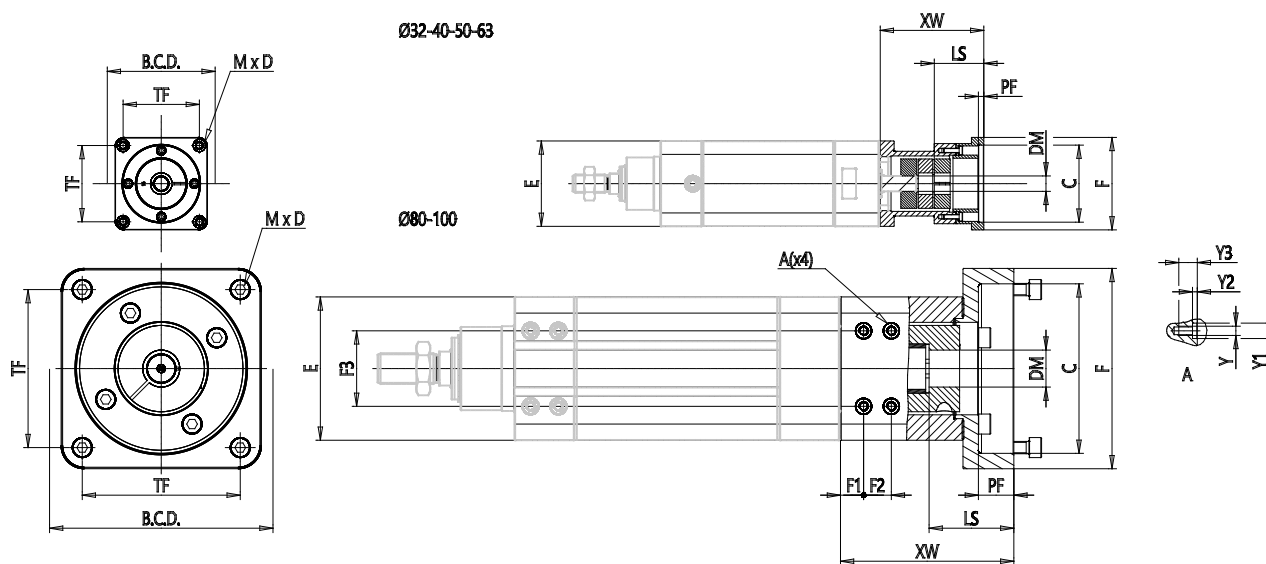

DIMENSIONS

E (mm)	46.5
Weight (g)	240