

Kit for axial connection - Mod. AM

Product code: AM-6E-40-0024P

Datasheet creation date: 07/03/2025 15:43

Check the most updated document online [click here](#)



TECHNICAL DATA

Mod.	AM-6E-40-0024P
------	----------------

Kit for axial connection - Mod. AM

Product code: AM-6E-40-0024P

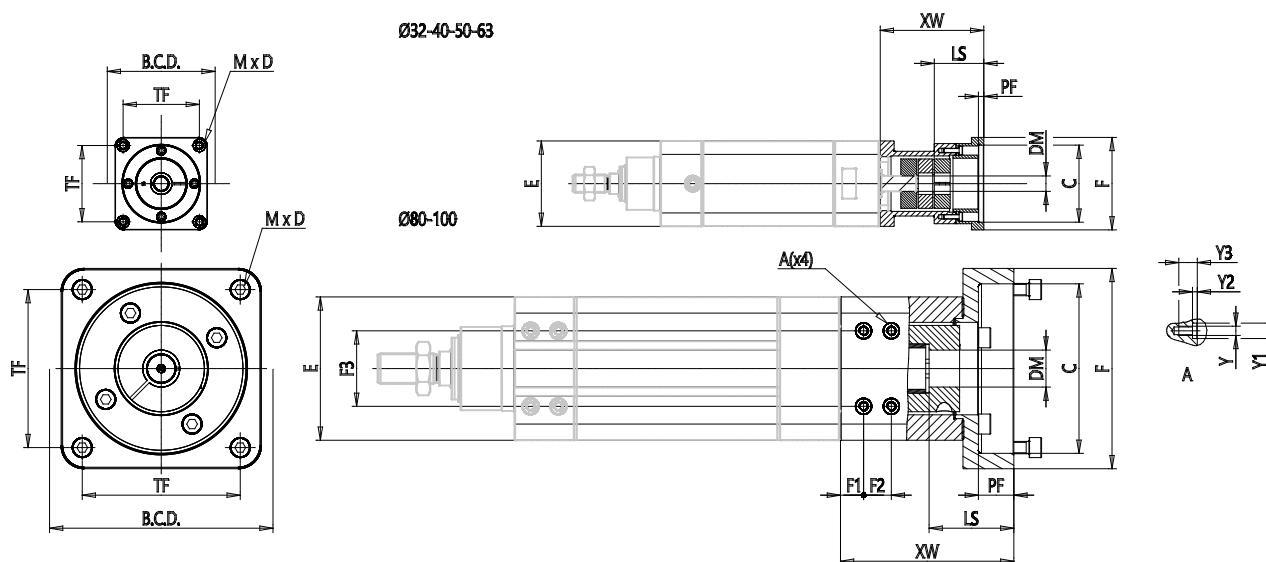

DIMENSIONS

E (mm)	55.4
Weight (g)	365