

Proportional valve- 22mm - Series AP

Product code: AP-7215-HR2-U712

Datasheet creation date: 10/03/2025 11:07

Check the most updated document online [click here](#)



TECHNICAL DATA

Series	AP
Body	7= size 22mm
Number of ways	2= 2way
Function	1= NC
Connection	5 = lower flanged body
Nominal diameter (mm)	H= Ø 1.2 mm
Seals material	R= NBR
Body material	2= BRASS
Encapsulating material	U= PET
Dimensions of the solenoid (mm)	7= 22x22 DIN 43650 B
Solenoid voltage (V DC)	12= 12 V DC 6.5W
Coil orientation	= fastons opposite pneumatic doors, same output side
Version	= uncertified version
Kv (l/min)	0.700
Max pressure (bar)	8.000
Max flow (Nl/min)	85.000

Proportional valve- 22mm - Series AP

Product code: AP-7215-HR2-U712

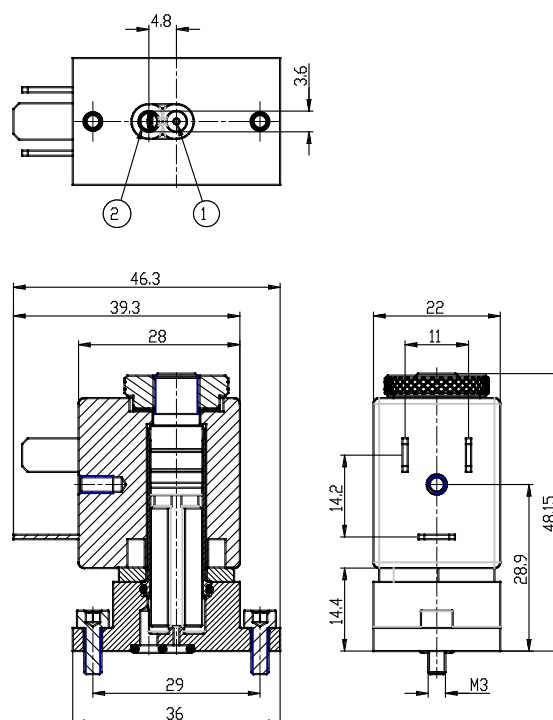

DIMENSIONS

Series	AP
Body	7= size 22mm
Number of ways	2= 2way
Function	1= NC
Connection	5 = lower flanged body
Nominal diameter (mm)	H= Ø 1.2 mm
Seals material	R= NBR
Body material	2= BRASS
Encapsulating material	U= PET
Dimensions of the solenoid (mm)	7= 22x22 DIN 43650 B
Solenoid voltage (V DC)	12= 12 V DC 6.5W
Coil orientation	= fastons opposite pneumatic doors, same output side
Version	= uncertified version
Kv (l/min)	0.700
Max pressure (bar)	8.000
Max flow (Nl/min)	85.000