

Rotary cylinders - Series ARP

Product code: ARP-003-2AA-F0305-AEX

Datasheet creation date: 07/03/2025 17:51

Check the most updated document online [click here](#)



TECHNICAL DATA

Series	ARP
Size	003 = torque force 24 Nm
Operation	2A = double-acting
Rotation angle (°)	A = 90°
Interface for flange (iso 5211)	F0305
Materials	A = standard anodized
Atex	EX

Rotary cylinders - Series ARP

Product code: ARP-003-2AA-F0305-AEX

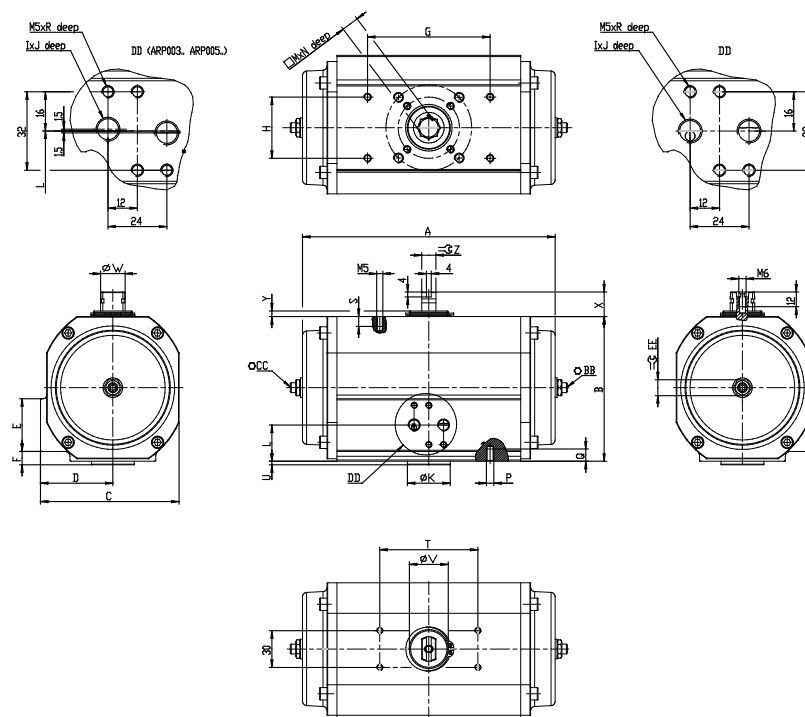

DIMENSIONS

ISO	F04
A (mm)	149.5
B (mm)	70.0
C (mm)	69.5
D (mm)	38.0
E (mm)	49.0
F (mm)	10.5
G (mm)	0
H (mm)	0
I	G1/8
J (mm)	10
ØK (mm)	25
L (mm)	32.0
M (mm)	9
N (mm)	11
P (mm)	-
Q (mm)	0
R (mm)	8
S (mm)	8
T (mm)	80
U (mm)	1.5
ØV (mm)	32.0
ØW (mm)	20

X (mm)	20
Y (mm)	4.5
Z (mm)	11.5
BB (mm)	0
CC (mm)	4
EE (mm)	13