

Rotary cylinders - Series ARP

Product code: ARP-055-2AA-F1210-AEX

Datasheet creation date: 07/03/2025 17:52

Check the most updated document online [click here](#)



TECHNICAL DATA

Series	ARP
Size	055 = torque force 597 Nm
Operation	2A = double-acting
Rotation angle (°)	A = 90°
Interface for flange (iso 5211)	F1210
Materials	A = standard anodized
Atex	EX

Rotary cylinders - Series ARP

Product code: ARP-055-2AA-F1210-AEX

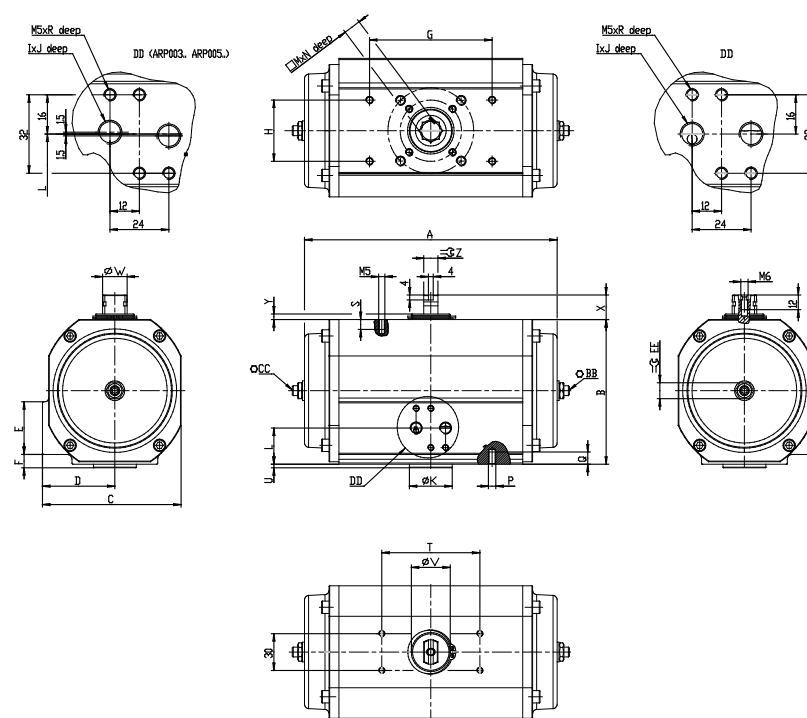

DIMENSIONS

ISO	F12-F10
A (mm)	312.0
B (mm)	207.5
C (mm)	191.0
D (mm)	95.5
E (mm)	43.0
F (mm)	20.5
G (mm)	161
H (mm)	73
I	G1/4
J (mm)	12
ØK (mm)	85
L (mm)	42.0
M (mm)	27
N (mm)	30
P (mm)	M8
Q (mm)	15
R (mm)	8
S (mm)	5
T (mm)	130
U (mm)	3.0
ØV (mm)	61.0
ØW (mm)	40

X (mm)	30
Y (mm)	7.5
Z (mm)	25.5
BB (mm)	10
CC (mm)	10
EE (mm)	30