

Rotary cylinders - Series ARP

Product code: ARP-150-1BA-F1400-AEX

Datasheet creation date: 07/03/2025 17:53

Check the most updated document online [click here](#)



TECHNICAL DATA

Series	ARP
Size	150 = torque force 1655 Nm
Operation	1B = single-acting, minimum pressure of 5 bar
Rotation angle (°)	A = 90°
Interface for flange (iso 5211)	F1400
Materials	A = standard anodized
Atex	EX

Rotary cylinders - Series ARP

Product code: ARP-150-1BA-F1400-AEX

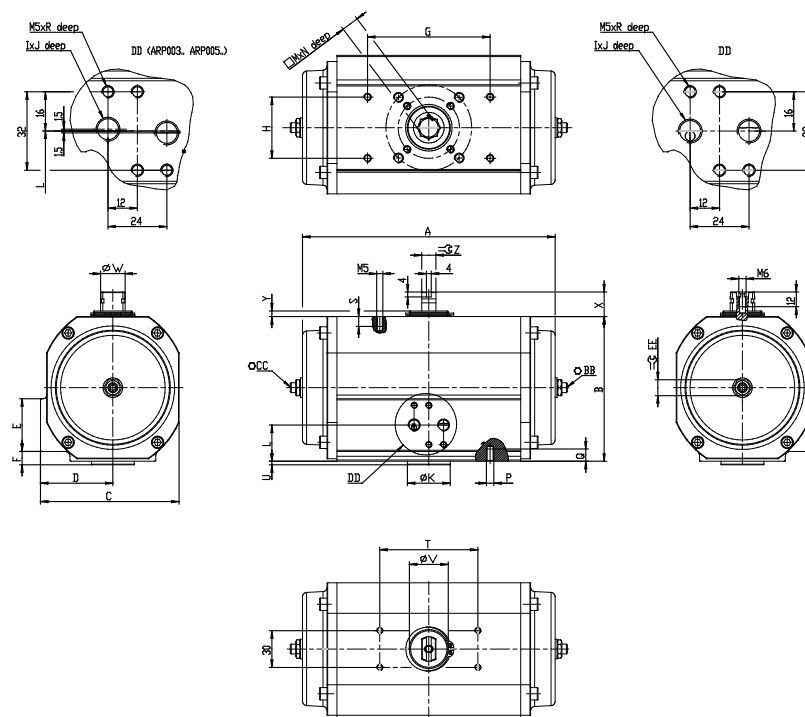

DIMENSIONS

ISO	F14
A (mm)	394.0
B (mm)	304.0
C (mm)	280.0
D (mm)	140.0
E (mm)	48.5
F (mm)	51.5
G (mm)	244
H (mm)	117
I	G1/4
J (mm)	12
ØK (mm)	100
L (mm)	76.0
M (mm)	36
N (mm)	40
P (mm)	M12
Q (mm)	22
R (mm)	8
S (mm)	6
T (mm)	130
U (mm)	3.0
ØV (mm)	78.0
ØW (mm)	40

X (mm)	30
Y (mm)	7.0
Z (mm)	25.5
BB (mm)	12
CC (mm)	12
EE (mm)	36