

Series ASX angle seat valve - flanged - Series ASX

Product code: ASX21-W015F2-04012

Datasheet creation date: 10/03/2025 11:02

Check the most updated document online [click here](#)



TECHNICAL DATA

Series	AS
Actuator	X = metal actuator
Body material	2 = 316 stainless steel
Function	1 = 2/2 NC
Flow direction	W = under seat (antiwater hammer)
Diameter	DN 15
Connection	F2 = flange DIN 2543
Actuator size	Ø40 mm
Actuator material	1 = 304 stainless steel
Gaskets	2 = for standard temperature -10 / 180°C
Options	= None

Series ASX angle seat valve - flanged - Series ASX

Product code: ASX21-W015F2-04012

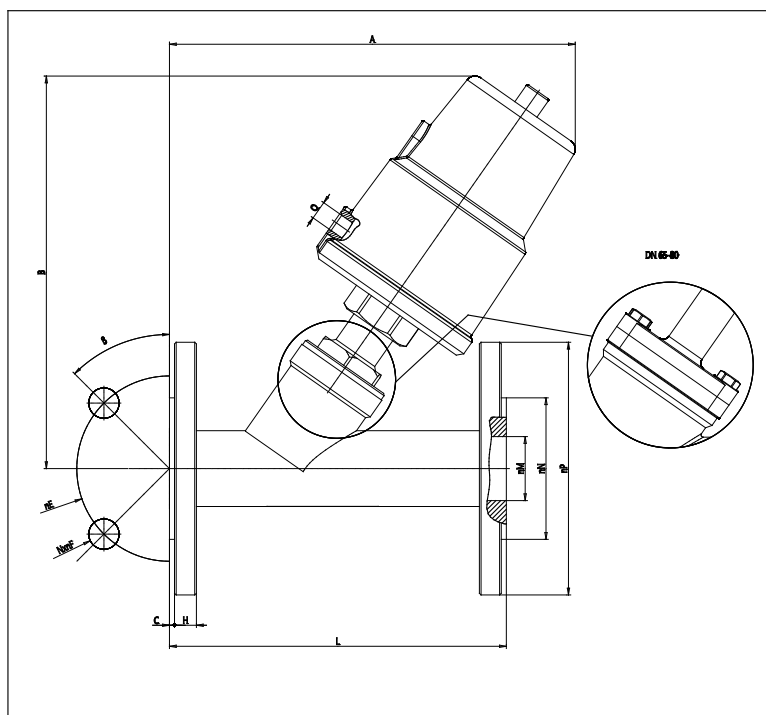

DIMENSIONS

DN	15
M	16
N	45
P	95
E	65
F	4x14
β	45°
A	135
B	125
L	130
C	2
H	14
Q	1/8"