

Series ASX angle seat valve - flanged - Series ASX

Product code: ASX21-W025F2-06312

Datasheet creation date: 10/03/2025 11:04

Check the most updated document online [click here](#)



TECHNICAL DATA

Series	AS
Actuator	X = metal actuator
Body material	2 = 316 stainless steel
Function	1 = 2/2 NC
Flow direction	W = under seat (antiwater hammer)
Diameter	DN 25
Connection	F2 = flange DIN 2543
Actuator size	Ø63 mm
Actuator material	1 = 304 stainless steel
Gaskets	2 = for standard temperature -10 / 180°C
Options	= None

Series ASX angle seat valve - flanged - Series ASX

Product code: ASX21-W025F2-06312

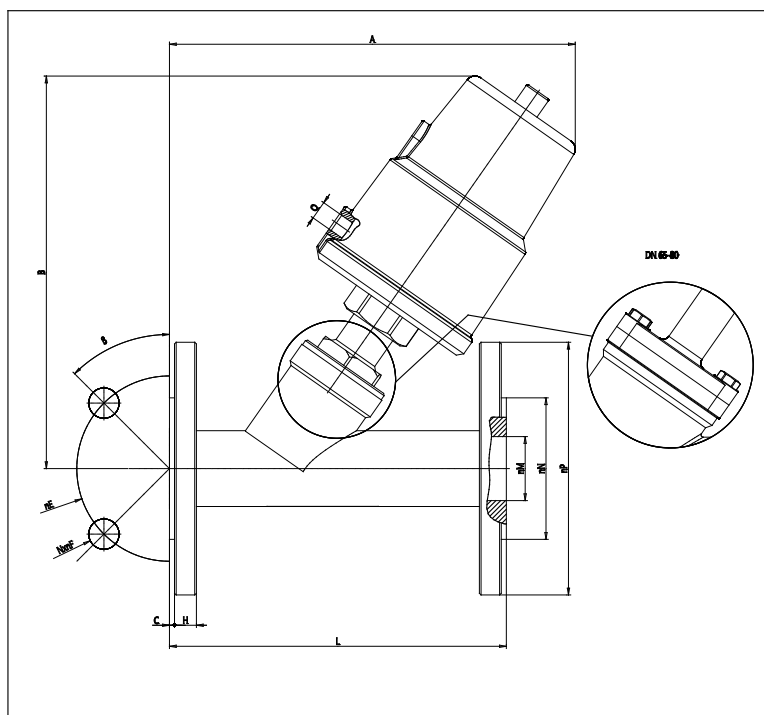

DIMENSIONS

DN	25
M	26
N	65
P	115
E	85
F	4x14
β	45°
A	190
B	175
L	160
C	2
H	14
Q	1/8"