

Series ASX angle seat valve - welding ends - Series ASX

Product code: ASX21-W032H7-06312

Datasheet creation date: 10/03/2025 11:05

Check the most updated document online [click here](#)



TECHNICAL DATA

Series	AS
Actuator	X = metal actuator
Body material	2 = 316 stainless steel
Function	1 = 2/2 NC
Flow direction	W = under seat (antiwater hammer)
Diameter	DN 32
Connection	H7 = welding ends DIN 11850-2 / DIN 11866-A
Actuator material	1= 304 stainless steel
Gaskets	2 = for standard temperature -10 / 180 ° C
Options	= None

Series ASX angle seat valve - welding ends - Series ASX

Product code: ASX21-W032H7-06312

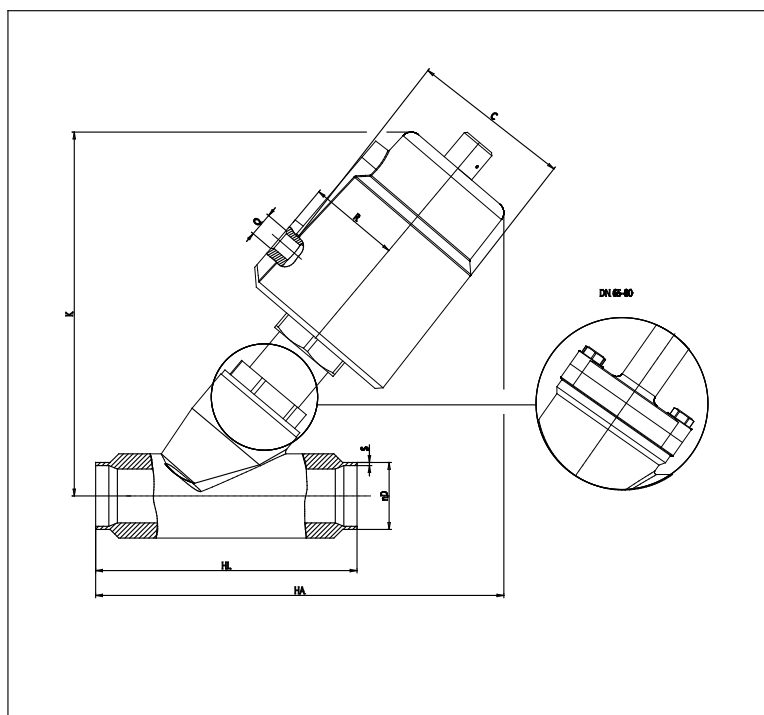

DIMENSIONS

DN	32
D	35
S	1.5
HA	186
HL	125
C	75.0
R	41
K	174
Q	1/8"