

Series ASX angle seat valve - flanged - Series ASX

Product code: ASX21-W040F2-09013

Datasheet creation date: 10/03/2025 11:05

Check the most updated document online [click here](#)



TECHNICAL DATA

Series	AS
Actuator	X = metal actuator
Body material	2 = 316 stainless steel
Function	1 = 2/2 NC
Flow direction	W = under seat (antiwater hammer)
Diameter	DN 40
Connection	F2 = flange DIN 2543
Actuator size	Ø90 mm
Actuator material	1 = 304 stainless steel
Gaskets	3 = for high temperature 25 / 220 °C
Options	= None

Series ASX angle seat valve - flanged - Series ASX

Product code: ASX21-W040F2-09013

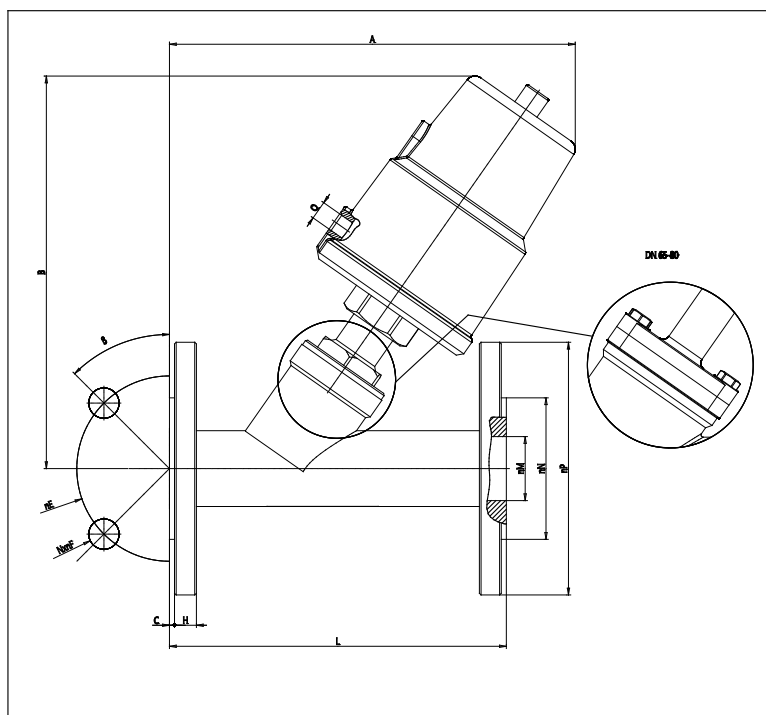

DIMENSIONS

DN	40
M	38
N	84
P	150
E	110
F	4x18
β	45°
A	250
B	240
L	200
C	3
H	16
Q	1/8"