

Series ASX angle seat valve - flanged - Series ASX

Product code: ASX21-Y015F2-05012

Datasheet creation date: 10/03/2025 11:03

Check the most updated document online [click here](#)



TECHNICAL DATA

Series	AS
Actuator	X = metal actuator
Body material	2 = 316 stainless steel
Function	1 = 2/2 NC
Flow direction	Y = above seat
Diameter	DN 15
Connection	F2 = flange DIN 2543
Actuator size	Ø50 mm
Actuator material	1 = 304 stainless steel
Gaskets	2 = for standard temperature -10 / 180°C
Options	= None

Series ASX angle seat valve - flanged - Series ASX

Product code: ASX21-Y015F2-05012

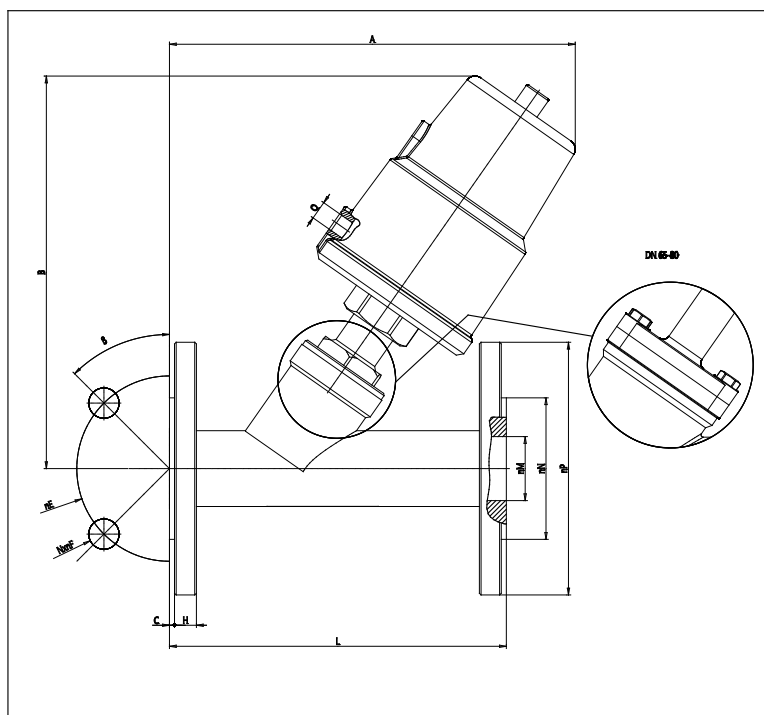

DIMENSIONS

DN	15
M	16
N	45
P	95
E	65
F	4x14
β	45°
A	1456
B	140
L	130
C	2
H	14
Q	1/8"