

Foot mount - Mod. B-54

Product code: B-54-16

Datasheet creation date: 07/03/2025 16:00

Check the most updated document online [click here](#)



TECHNICAL DATA

Mod.	B-54-16
------	---------

Foot mount - Mod. B-54

Product code: B-54-16

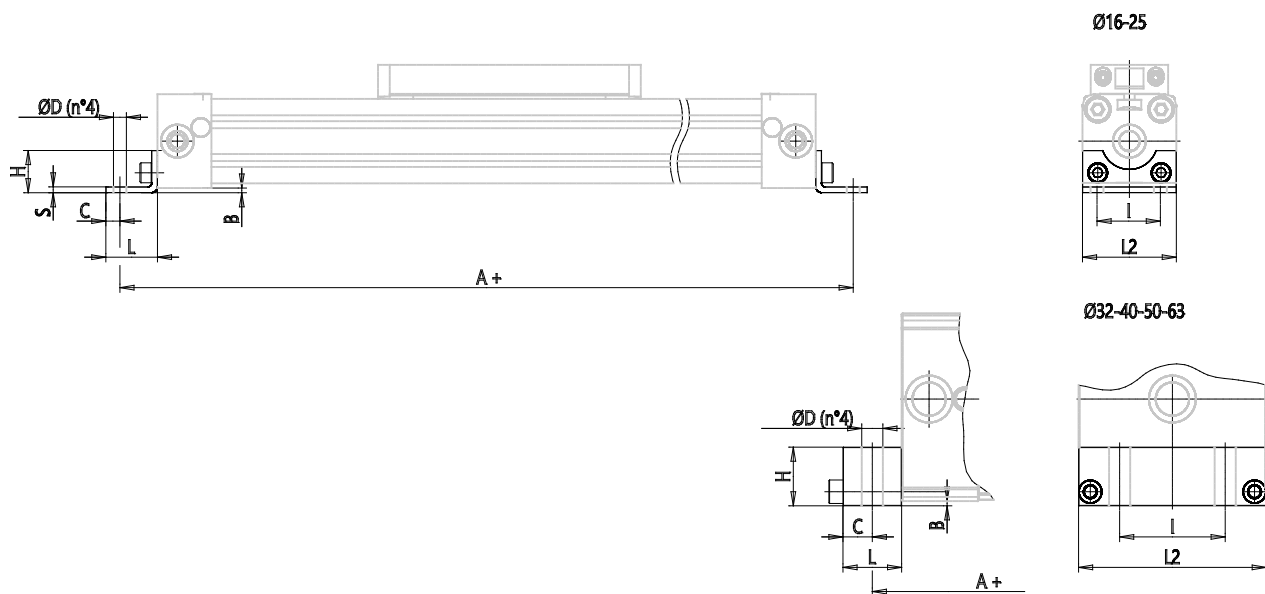

DIMENSIONS

A (mm)	150
L (mm)	14
L2 (mm)	26
H (mm)	12.5
I (mm)	18
B (mm)	1.5
C (mm)	4.0
D (mm)	3.6
S (mm)	1.5