

Foot mount - Mod. B-54

Product code: B-54-25

Datasheet creation date: 07/03/2025 16:00

Check the most updated document online [click here](#)



TECHNICAL DATA

Mod.	B-54-25
------	---------

Foot mount - Mod. B-54

Product code: B-54-25

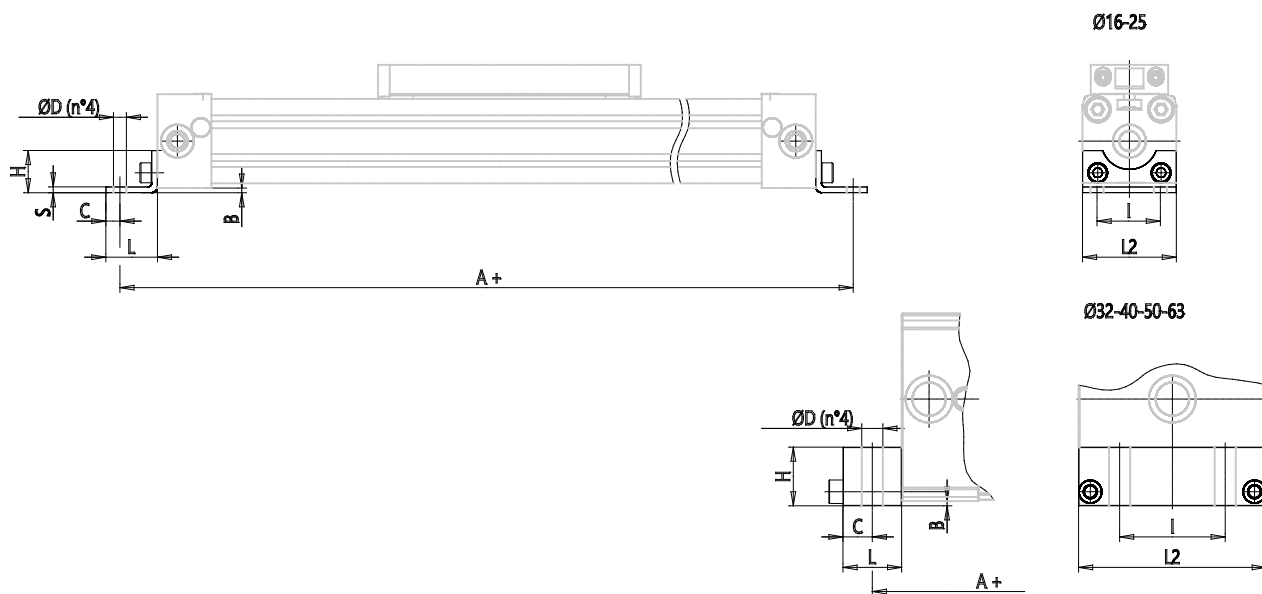

DIMENSIONS

A (mm)	232
L (mm)	22
L2 (mm)	40
H (mm)	18.0
I (mm)	27
B (mm)	2.0
C (mm)	6.0
D (mm)	5.5
S (mm)	2.5