

Foot mount - Mod. B-54

Product code: B-54-50

Datasheet creation date: 07/03/2025 16:01

Check the most updated document online [click here](#)



TECHNICAL DATA

Mod.	B-54-50
------	---------

Foot mount - Mod. B-54

Product code: B-54-50

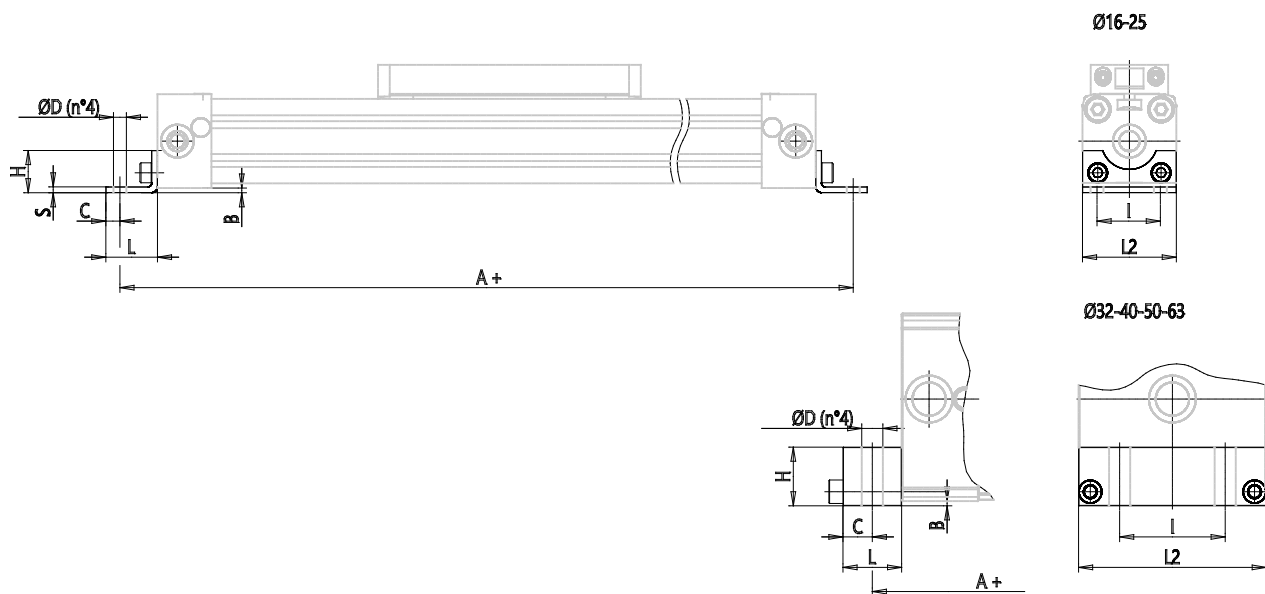

DIMENSIONS

A (mm)	375
L (mm)	25
L2 (mm)	80
H (mm)	25.0
I (mm)	45
B (mm)	1.0
C (mm)	12.5
D (mm)	9.0
S (mm)	0.0