

Foot mount (high) - Mod. BA-52

Product code: BA-52-32P

Datasheet creation date: 07/03/2025 16:00

Check the most updated document online [click here](#)



TECHNICAL DATA

Mod.	BA-52-32
Materials	P = anodized AL profile tube, NBR and Polyurethane seals, standard carriage

Foot mount (high) - Mod. BA-52

Product code: BA-52-32P

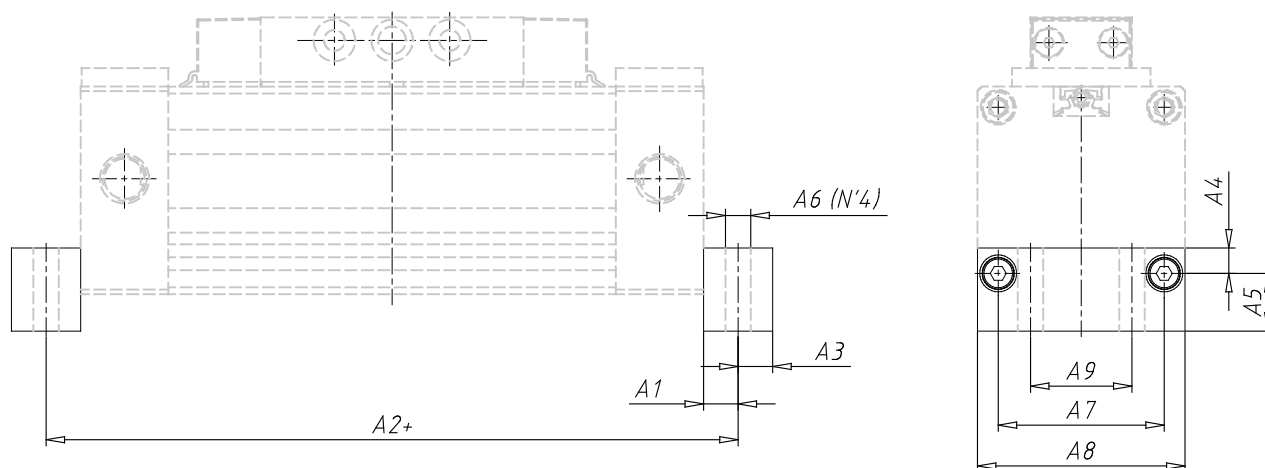

DIMENSIONS

A1 (mm)	7.5
A2 (mm)	255
A3 (mm)	7.5
A4 (mm)	16.5
A5 (mm)	17.5
Ø A6 (mm)	7.0
A7 (mm)	41
A8 (mm)	51
A9 (mm)	25