

Pressure booster - Series BPA

Product code: BPA-063-R2

Datasheet creation date: 20/05/2026 08:04

Check the most updated document online [click here](#)



TECHNICAL DATA

Series	BPA
Size	063
Regulator	R2 = with regulator (P.IN 2-10bar - P.OUT 0-16bar)

Pressure booster - Series BPA

Product code: BPA-063-R2

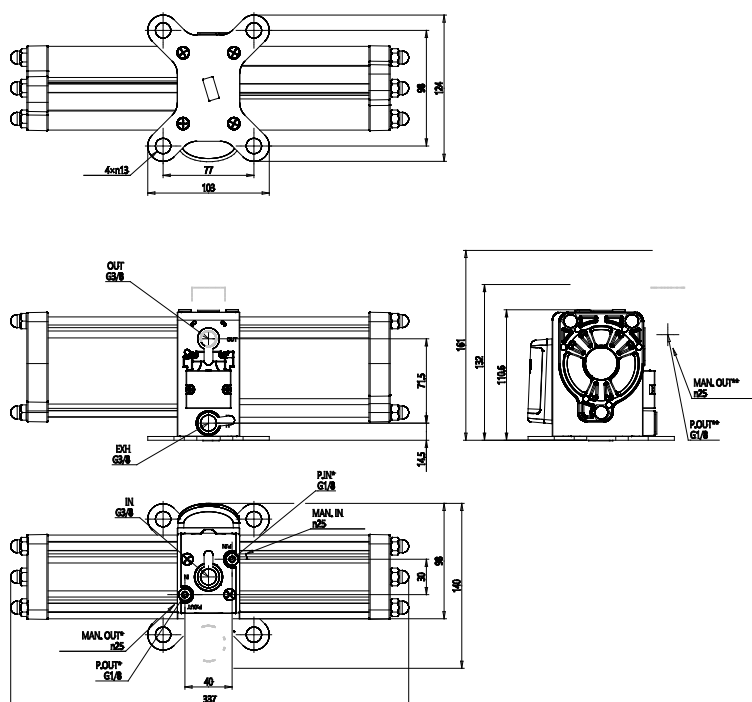

DIMENSIONS

Series	BPA
Size	063
Regulator	R2 = with regulator (P.IN 2-10bar - P.OUT 0-16bar)