

Pressure booster - Series BPA

Product code: BPA-100-R1

Datasheet creation date: 20/05/2026 08:04

Check the most updated document online [click here](#)



TECHNICAL DATA

Series	BPA
Size	100
Regulator	R1 = with regulator (P.IN 2-8bar - P.OUT 0-10bar)

Pressure booster - Series BPA

Product code: BPA-100-R1

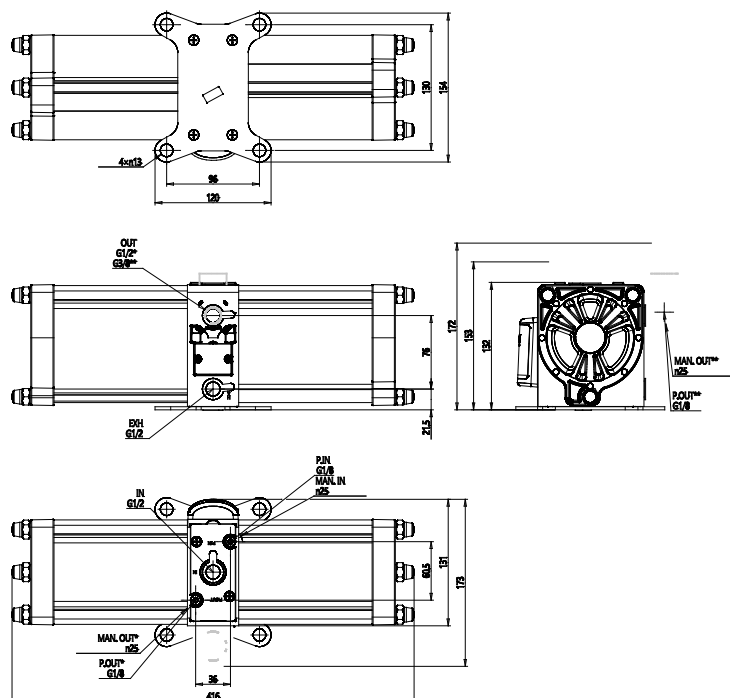

DIMENSIONS

Series	BPA
Size	100
Regulator	R1 = with regulator (P.IN 2-8bar - P.OUT 0-10bar)