

Mounting accessories - Mod. C-CGP

Product code: C-CGP-16

Datasheet creation date: 07/03/2025 16:10

Check the most updated document online [click here](#)



■ TECHNICAL DATA

Mod. (mm)	C-CGP-16
-----------	----------

Mounting accessories - Mod. C-CGP

Product code: C-CGP-16

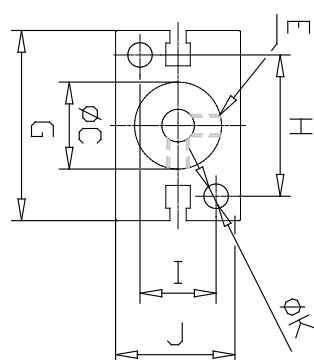
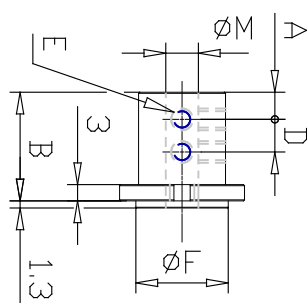

DIMENSIONS

A (mm)	5
B (mm)	20.5
C (mm)	16
D (mm)	6
E	M4
F (mm)	17
G (mm)	35
H (mm)	26
I (mm)	14
J (mm)	23
K (mm)	4.5
M (mm)	6