

Mounting accessories - Mod. C-CGP

Product code: C-CGP-25

Datasheet creation date: 07/03/2025 16:10

Check the most updated document online [click here](#)



■ TECHNICAL DATA

Mod. (mm)	C-CGP-25
-----------	----------

Mounting accessories - Mod. C-CGP

Product code: C-CGP-25

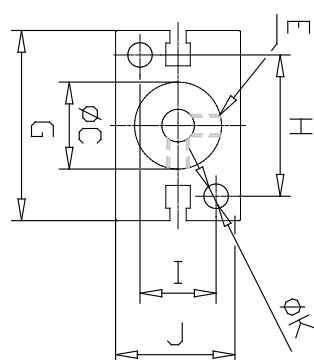
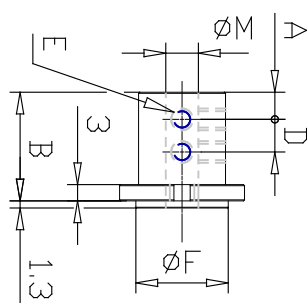

DIMENSIONS

A (mm)	8
B (mm)	30.5
C (mm)	25
D (mm)	10
E	M4
F (mm)	26
G (mm)	53
H (mm)	40
I (mm)	20
J (mm)	33
K (mm)	6.6
M (mm)	10