

Mod. C6510 - Series 6000 fittings

Product code: C6510 10-1/2

Datasheet creation date: 10/03/2025 09:27

Check the most updated document online [click here](#)



TECHNICAL DATA

Mod.	C6510 10-1/2
------	--------------

Mod. C6510 - Series 6000 fittings

Product code: C6510 10-1/2

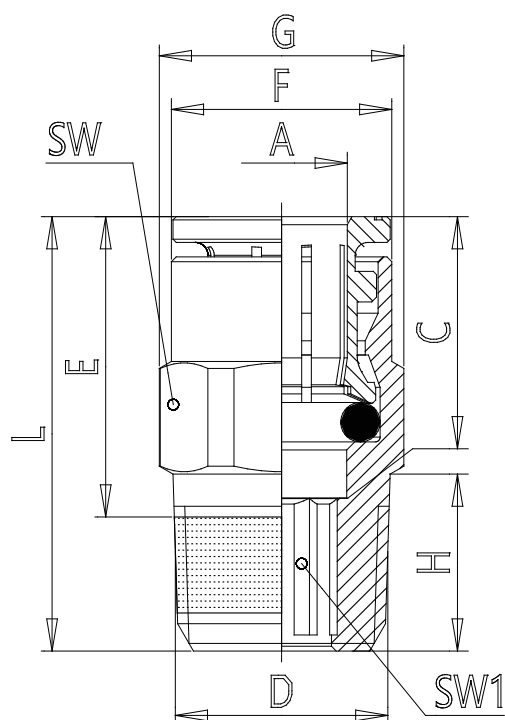

DIMENSIONS

A (mm)	10
D (mm)	R1/2
C (mm)	20.2
(mm)	17.5
F (mm)	16.0
G (mm)	24.5
H (mm)	14.0
L (mm)	28.5
SW (mm)	22
SW1 (mm)	8.0
Weight (g)	41