

Mod. C6510 - Series 6000 fittings

Product code: C6510 12-3/8

Datasheet creation date: 10/03/2025 09:28

Check the most updated document online [click here](#)



■ TECHNICAL DATA

Mod.	C6510 12-3/8
------	--------------

Mod. C6510 - Series 6000 fittings

Product code: C6510 12-3/8

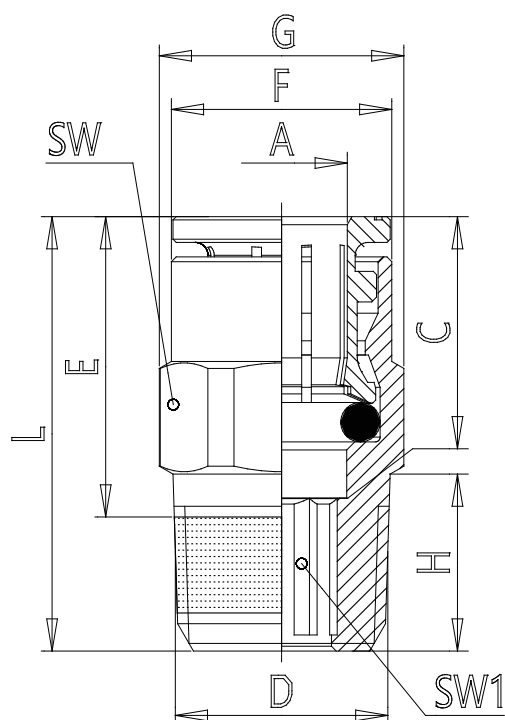

DIMENSIONS

A (mm)	12
D (mm)	R3/8
C (mm)	19.2
(mm)	21.5
F (mm)	18.3
G (mm)	20.5
H (mm)	11.5
L (mm)	31.0
SW (mm)	19
SW1 (mm)	9.0
Weight (g)	26