

Self-compensating adaptor - Mod. CF-50

Product code: CF-50-50

Datasheet creation date: 07/03/2025 16:00

Check the most updated document online [click here](#)



■ TECHNICAL DATA

Mod.	CF-50-50
------	----------

Self-compensating adaptor - Mod. CF-50

Product code: CF-50-50

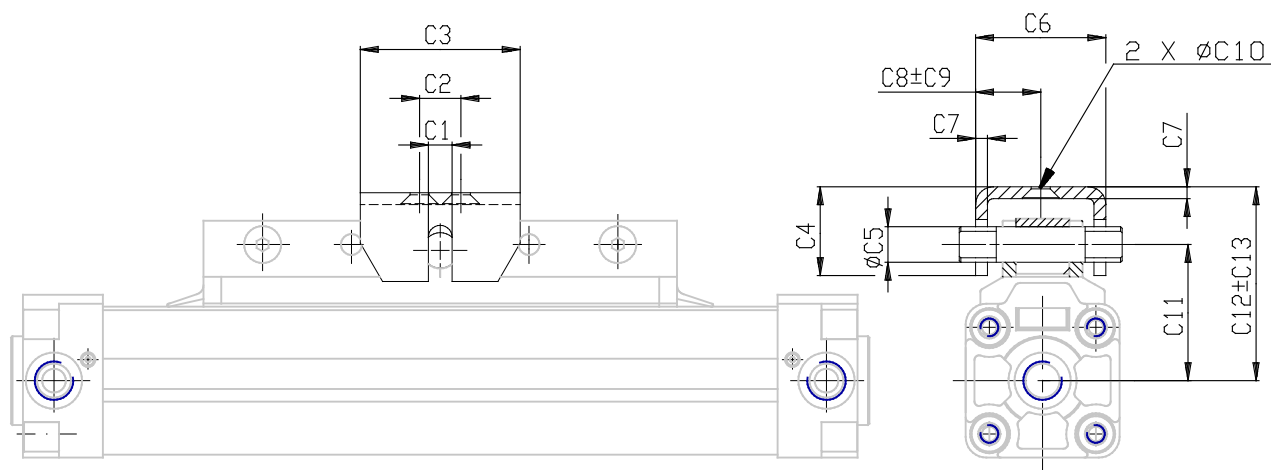

DIMENSIONS

C1 (mm)	9.3
C2 (mm)	80
C3 (mm)	114.6
C4 (mm)	37.1
C5 (mm)	11.9
C6 (mm)	43.9
C7 (mm)	6.1
C8 (mm)	22.0
C9 (mm)	1.8
C10 (mm)	8.6
C11 (mm)	59
C12 (mm)	89.2
C13 (mm)	5.9