

Direct acting solenoid valves - Series CFB

Product code: CFB-D22F-W1-B8E

Datasheet creation date: 10/03/2025 11:49

Check the most updated document online [click here](#)



TECHNICAL DATA

Series	CFB
Operation	D = direct
Number of ways - position	2 = 2/2 way - NC
Connection	2 = G1/4
Nominal diameter	F = 4 mm
Diaphragm material	W = FKM
Body material	1= brass
Dimension solenoid	B8 = 30mm
Solenoid voltage	E = 230V AC 50/60 Hz

Direct acting solenoid valves - Series CFB

Product code: CFB-D22F-W1-B8E

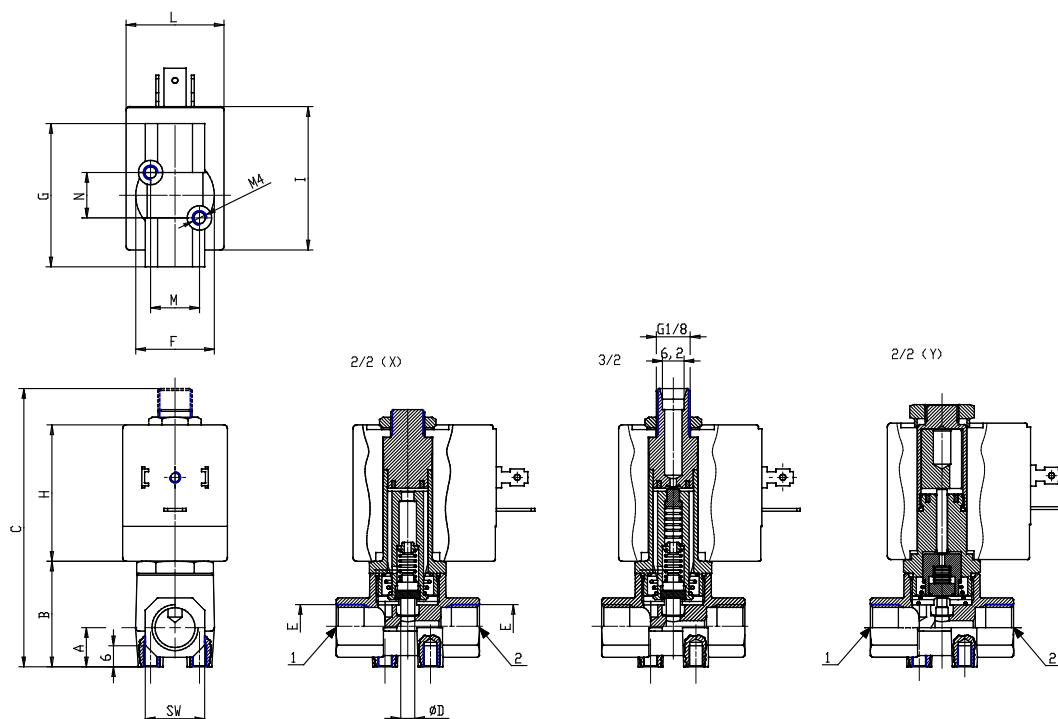

DIMENSIONS

Series	CFB
Operation	D = direct
Number of ways - position	2 = 2/2 way - NC
Connection	2 = G1/4
Nominal diameter	F = 4 mm
Diaphragm material	W = FKM
Body material	1= brass
Dimension solenoid	B8 = 30mm
Solenoid voltage	E = 230V AC 50/60 Hz